

BATTLE'S OVER



A NATION'S TRIBUTE

11TH NOVEMBER 2018

100 YEARS OF REMEMBRANCE

*March no more my soldier laddie,
There is peace where there once was war.
Sleep in peace my soldier laddie,
Sleep in peace, now the battle's over.*

YOUR GUIDE TO TAKING PART



**BATTLE'S
OVER**

A NATION'S TRIBUTE
11TH NOVEMBER 2018
100 YEARS OF REMEMBRANCE

*Certificate of Grateful Recognition
11th November 2018*

With sincere thanks for your contribution to Battle's Over,
the international commemoration of the centenary
of the end of World War I.

In association with:

The Society of Editors, Army Cadet Force, Air Training Corps, Sea Cadet Corps, Combined Cadet Force, Association of English Cathedrals, Merchant Navy Association, Royal Naval Association, ABF The Soldiers' Charity, Royal Air Force Benevolent Fund, The Buglers Association of The Light Division & Rifles, Trinity House, National Association of Local Councils, National Association of Civic Officers, One Voice Wales, National Trust, English Heritage, Central Council of Bellringers, The College of Piping and the National Union of Mineworkers (formerly known as Miners Federation of Great Britain).



Bruno Peek

Bruno Peek LVO OBE OPR
Originator & Pageantmaster
Battle's Over - A Nation's Tribute
11th November 2018

This certificate can be downloaded at www.brunopeek.co.uk from 30th November 2018 to enable participants to print it off and frame it as a permanent reminder of their involvement in this unique tribute.



Contents

Page 4
Introduction

Page 6
Sleep in peace, now the battle's over

Page 7
History of the Last Post - 'The People's Anthem'

Page 8
The History of Church Bell ringing

Page 9
How to take part
& Beacon Lighting Ceremony

Page 10
WWI Beacons of Light,
your unique gas-fuelled Beacon

Page 11
WWI Beacons of Light,
Beacon Brazier

Page 12
WWI Beacons of Light,
Bonfire Beacon

Page 13
Your responsibility,
Legal Essentials and Safety

Page 14
Message from the First Sea Lord Admiral Sir Philip Jones
KCB ADC
Chief of Naval Staff

Page 16
Message from General Sir Nicholas Patrick Carter
KCB CBE DSO ADC Gen
Chief of the General Staff

Page 18
Message from the Air Chief Marshal Sir Stephen Hillier
KCB CBE DFC ADC MA RAF
Chief of the Air Staff

Page 20
Message from Captain John Sail - National Chairman,
The Merchant Navy Association

Page 22
Battle's Over - A Nation's Tribute
& WWI Beacons of Light
Chosen Charities

Page 23
Acknowledgements



Introduction

BATTLE'S O V E R



A NATION'S TRIBUTE

11TH NOVEMBER 2018

100 YEARS OF REMEMBRANCE

*Your chance to pay your
personal and community
tribute to those millions
that gave their lives
for their country
or returned home wounded
during or after the dreadful
darkness of four years of War
1914 - 1918*

On 11th November 2018, the United Kingdom and its friends overseas will mark the day 100 years ago when the guns fell silent at the end of the First World War.

You can play your part in remembering the sacrifice of millions of men and women by joining us in Battle's Over, a unique series of events in the morning and evening involving organisations and communities the length and breadth of our nation and in many countries abroad.

- **Battle's Over - Sleep in peace, now the battle's over**
- **Battle's Over - The Last Post**
- **Battle's Over - WWI Beacons of Light**
- **Battle's Over - Let the Bells Ring Out**

6.00am - Battle's Over - Sleep in peace, now the battle's over

The sound of 1,000 bagpipes will fill the air before dawn has broken on 11th November 2018. In cities and towns throughout the land individual pipers will play Battle's O'er - a traditional air played by pipers after a battle. heralding the start of the day's commemorations, they will play the haunting tune outside churches and cathedrals, in market squares and muddy fields, on hilltops and high streets, in valleys and village greens throughout the United Kingdom, Channel Islands and the Isle of Man, and at scores of locations overseas, including Australia, Canada, the USA, Germany, South Africa, France, Spain, Denmark, Israel and Somalia to name but a few.

A lone piper will play Battle's O'er in front of the Tomb of the Unknown Warrior at Westminster Abbey, London, with others undertaking a similar performance in front of cathedrals in the UK. At the same time, pipers everywhere will be playing the same tune in their local communities.

Following the playing of this piece of music at the Merchant Navy Associations National Memorial, Trinity Square Gardens, Tower Hill, London, at 6am, through to 7pm, when a WWI Beacon of Light will be lit, the 15,000 names of those brave Merchant Navy Seamen who lost their lives during this

dreadful war will be read out by a range of people from all over the United Kingdom, in remembrance of the sacrifices made.

We anticipate that this unique tribute, organised in association with the Glasgow-based College of Piping, will start the centenary media coverage on television and radio, and will provide some of the day's most moving and atmospheric sights and sounds, so if you wish to encourage a local Piper to participate by playing Battle's O'er at a location of their choice (excluding Cathedral's), please ask them to register asap, providing the following information to:

battlesoer@collegeofpiping.org

Name of Piper, Address, Country, County, Tel, Email

6.55pm Battle's Over - The Last Post

In association with the Air Training Corps, Army Cadet Force, Sea Cadet Force and the Light Infantry Buglers Association, the Last Post will be played at many of the 1,000 WWI Beacon sites throughout the United Kingdom, involving young people and others paying their personal tribute to those that gave their lives during World War I.

7.00pm Battle's Over - WWI Beacons of Light

Later that day, after darkness has fallen, more than 1,000 Beacons of Light will be lit throughout the United Kingdom, Channel Islands, Isle of Man and UK Overseas Territories.

This is a commemoration inspired by a comment made on 3rd August 1914 by Britain's Foreign Minister, Sir Edward Grey. He was looking out of his office window at dusk as gas lights were being lit along London's Mall when he remarked to a friend, "The lamps are going out all over Europe; we shall not see them lit again in our lifetime."

Our country was about to be plunged into the darkness of the First World War, and it would be four long years before Britain and Europe would again experience the light of peace.



In remembrance of the end of the war and the millions who were killed or came home dreadfully wounded, Beacons of Light will be lit around the country at 7pm on 11th November 2018.

The event will also commemorate the huge army of men and women on the home front who, often in dangerous and exhausting conditions, underpinned the war effort - keeping the wheels of industry turning and bringing home the harvests. The beacons will symbolise the light of hope that emerged from the darkness of war.

Among the communities and other organisations that have confirmed their involvement are the Tan Hill Inn, Yorkshire Dales, the highest pub in Great Britain; Unst, the most northerly inhabited island in Scotland; St David's, the most westerly city in Wales; Lowestoft, Suffolk, the most easterly town in England, and St Macartin's Cathedral, Enniskillen, the most westerly location in the United Kingdom. We do hope that your council and community will also choose to take part in this historic tribute.

There are a number of cost-effective ways of participating.

- (1) Use existing beacon braziers set on tall wooden poles and gas-fuelled beacons previously used for other historic anniversaries, celebrations and commemorations.
- (2) Build and light a traditional bonfire beacon.
- (3) Purchase the gas-fuelled beacon being specially produced for this project. Afterwards, it can be stored and used for future events. See page 10.
- (4) Build and erect a new beacon brazier on a tall wooden pole, using it as a permanent tribute to those that lost their lives in your local community during World War I. See page 11. (You may need to apply for planning permission so please contact your Local Authority Planning Department to seek their advice).

Councils, organisations and individuals taking part will be able to immediately download the official Battle's Over logo free of charge by going to www.brunopeek.co.uk and similar for the special certificate shown on page 2 from 30th November 2018 by going to the same website as a permanent reminder of their involvement in this tribute.

Those wishing to participate in the lighting of the World War 1 Beacons of Light, please go to page 9.

As you will see from pages 15, 17, 19, and 21, we have four worthy and appropriate charities associated with this event, representing the Royal Navy, Army, Royal Air Force, and Merchant Navy. Please feel free to make donations direct to one or more of them. You may also wish to consider staging a public collection for them around the lighting of your beacon.

7.05pm Battle's Over - Ringing out for peace!

As beacons blaze around the country, bells in 1,000 churches and cathedrals will ring out in celebration of the end of the First World War. Many people in Britain live within hearing of church bells, which call congregations to prayer and mark special occasions. But the sound of mighty bells, some of which are hundreds of years old, also provides a stirring soundtrack to historic events.

The ringing of bells to celebrate the end of the Great War is being organised in association with the Central Council of Church Bell Ringers, the representative body for groups who ring bells in the English tradition with rope and wheel. It was founded in 1891 and represents 65 affiliated societies of local ringers from all over the British Isles and many other countries from Australasia to North America to Africa.

The stirring sound of church and cathedral bells will provide a fitting conclusion to a day of contemplation, commemoration and, ultimately, celebration as our country and other nations reflect on events a century ago on the battlefields of Europe and at home in our factories and farms.

Please encourage your local Cathedral, Minster or Church to participate by ringing their bells at 7.05pm that evening, asking them to provide us with the following information to:

brunopeek@mac.com
Name of Cathedral, Minster, or Church, Address, Country, County, Name of Contact, Tel, Email

Please join us

Those millions of brave men, along with the many left at home, did their duty for their country during the dark days of war, so let us do our duty by them, remembering and honouring them through Battle's Over.

We encourage you therefore to join the many thousands of people already taking part, by participating in this unique community project, commemorating the bravery and personal sacrifice made by so many, along with celebrating the light that emerged from the darkness of war

Please see acknowledgements from page 23 onwards. These will be updated every three months up to 31st October 2018.



Photo: Archant Norfolk



Bruno Peek

Bruno Peek LVO OBE OPR
Pageantmaster
Battle's Over - A Nation's Tribute



'Sleep in peace, now the battle's over'

"The origins of military music derive from the demands of war itself," wrote Lt. Col. David J. Murray in his seminal publication from 1994, *Music of the Scottish Regiments*. "From earliest times until the invention of radio as a means of communication, it had three principal functions. These were to pass orders and give signals in battle; to regulate the military day in camp and garrison; and 'to excite cheerfulness and alacrity in the soldier'."

The highland piper had been a prominent member of the social hierarchy of Scotland's clan system since the 15th century, when the piper seems to have ousted the bard and the harper from their positions. When the clan took the field as a fighting unit, the piper went with it, and was able, by means of the robust tone and volume of his instrument, both to entertain the men on the march to the battlefield and in their bivouacs, and also, importantly, to encourage them during the prelude to battle by playing the warlike music of the clan. In Gaelic, this rousing is called the 'bronsnachadh.'

The existence of pipes with a Scottish regiment dates to at least the 1680s. At the Battle of Waterloo the pipers played inside the squares as the French advanced, while on the march they played to cheer the soldiers up. All this changed with the arrival of the metalled road, which was to lead to the emergence of the bagpipe and drum combination, and to an avalanche of compositions in march tempo.

From the time of Waterloo, continuous efforts had been made to have the pipers recognised as an integral part of the musical resources of the Scottish regiments. The highland regiments owed the approval of their pipers to the indirect influence of Queen Victoria and it was she who decreed that "the pipers shall play in front" of the regiments. The Queen decided she must have her own piper and in 1843 Angus MacKay was appointed as the first Sovereign's Piper, a tradition that has been maintained by the monarch ever since.

Throughout history there are many examples of military pipers raising the morale of fighting troops at critical moments in battle. Piper George Findlater on the north-west frontier of Afghanistan in 1897, and Piper Daniel Laidlaw VC at the Battle of Loos in 1915 spring immediately to mind. The sound of the pipes boosted morale amongst the troops and intimidated the enemy but in doing so pipers were an easy target for the enemy, particularly during the Great War when they would lead the men 'over the top' of the trenches and into battle. Around 2,000 pipers were either killed or injured.



The origin of the Retreat march was to warn the soldier to return to his company in order to answer to his name at roll call. The tune, *When the Battle's Over* is a classic Retreat march. It was composed by Pipe Major William Robb (1863-1909) of the Argyll and Sutherland Highlanders and established itself quickly in the pipers' repertoire between the Boer War and Great War. It remains a very popular tune with pipers and pipe bands and it is fitting that it is the tune pipers will play at 06.00 hours throughout the United Kingdom and other countries throughout the world as part of the Battle's Over unique tribute that day.

In 1961, the singer Andy Stewart put lyrics to the tune. The chorus goes:

*March no more my soldier laddie,
There is peace where there once was war.
Sleep in peace my soldier laddie,
Sleep in peace, now the battle's over.*



Stuart Letford

Stuart Letford,
Manager, the College of Piping,
Glasgow, Scotland.



History of the Last Post - 'The People's Anthem'

"The Last Post" - A phrase that conjures up sombre thoughts, images, and a sense of finality and closure.

Although now recognised as the Bugle Call signifying the 'Final Farewell' at a military funeral or Remembrance Parade, it was originally a call used daily by the Army. It followed "The First Post" (which signalled the start of the Duty Officer's inspection of the sentry posts) and signalled that the inspection of the final sentry post had taken place and all was secure for the night. It was first published in 1790, and during any prolonged battle it was also sounded to signal that fighting was over for the day and that any combatants

who were still out in the field or were injured should find help or refuge by following the sound. From 1850 it became the custom overseas for it to be played when a soldier died or was killed in action and for the Regimental Bugler to play it at the graveside. The transition of the Call from being an official tune for timekeeping to one of mourning occurred during the 1880s when the overseas graveside tradition began to be observed at home.

Its use in a symbolic way during Remembrance Day parades and ceremonies signifies its acceptance as a token of remembrance as well as of death.

HG Wells is credited with calling the First World War (or the Great War as it was originally known) "the People's War" and the Last Post became the British People's Anthem, being heard with monotonous regularity during the War. The Last Post was not performed on the first Armistice Day in 1919, but was heard the following year and the practice has continued to this day.

Because of the intensity of this simple piece of music it has been incorporated into the Finale of "In Memoriam" by Robert Steadman as well as "The Armed Man" by Karl Jenkins.

In 1928, the custom started for the Call to be played at the Menin Gate, Ypres, Belgium every night at 8pm, apart from 20th May 1940 to 6th September 1944 due to the German occupation.



Flight Sergeant Isobel Hughes, 1211 (Swadlincote) Squadron, South East Midlands Wing



Flight Sergeant Geraint Jones, 1084 (Market Harborough) Squadron, South East Midlands Wing

Wing Commander G A Singleton
MCGI FRSA RAFVR(T)
Principal Director of Music

ROYAL
AIR FORCE
AIR CADETS
the next generation



Battle's Over - ringing out for peace

The History of 'English Change Ringing'

The sound of bells ringing is deeply rooted in British culture. Bells provide the grand soundtrack to our historic moments, calling us to wake, to pray, to work, to arms, to feast, to celebrate and, in times of crisis, to come together.

The early missionaries used small handbells to call people to worship, with bells being introduced into Christian churches around 400 AD.

Following the Reformation, many churches began to use a new technology of bells mounted on a whole wheel, which gave greater control, with the final refinement of a 'stay' and 'slider' to be able to 'set' the bell. The ringer could now rotate the bells 360 degrees and stop and start the ringing at will.

Competition developed for who had the most bells, and there was increased interest from lay people, who took over the belfry from the clergy. Rules evolved and 'changes' could be learned by heart to create patterns where the bells are never sounded in the same order twice. These compositions were named 'methods', often titled after the cities they were first rung in such as Norwich, London and Cambridge.

By the middle of the 18th century the ability to stand for three hours to ring a peal of 5040 changes was common, with a crowd of listeners eager to hear. Today bells ring out in the English style across the world.

During the First World War c1400 bell ringers lost their lives in service of their country. The Great War Memorial Book of Church Bell-Ringers who fell in the war is on display near the ringing chamber at St Paul's Cathedral, London. It bears the following inscription:

"They whom this book commemorates were numbered among those, who, at the call of King and Country, left all



that was dear to them, endured hardness, faced danger, and finally passed out of the sight of men by the path of duty and self-sacrifice, giving up their own lives that others might live in freedom."

At the end of the war the bells rang out across the country to celebrate the coming of peace, and have followed in that celebratory role ever since. 95% of bells in the UK 'rang in' the Millennium, a bell announced the opening of the London Olympics in 2012 and, as part of the Her Majesty the Queen's Diamond Jubilee celebrations, a floating belfry with eight bells led the Thames Pageant of 1,000 boats.

In 2017 a ring of 8 bells is being installed at St George's Memorial Chapel in Ypres, whose bell tower has stood empty due to lack of funds since the chapel was built in 1927. The project has cost £250,000 in total, but there has been no trouble raising those funds - the fallen of the Great War are not easily forgotten, and the sound of bells ringing out both in commemoration and to celebrate peace is clearly still as important to many as it was in 1918.

Christopher O'Mahony,
President of the Central
Council of Church Bell
Ringers.



How to take part & Beacon Lighting Ceremony

How to take part

Step 1: To confirm your involvement and assist us in easy communication and correct registration of your event, please be kind enough to undertake the following in FULL as soon as possible, sending it to Bruno Peek LVO OBE OPR, Pageantmaster, Battle's Over - A Nation's Tribute & WW1 Beacons of Light at - brunopeek@mac.com

If your event is a private occasion and NOT open to the public, and you do not want your involvement shown on any public or media listing, it is important that you confirm this when providing information requested below. Your participation will still be noted as part of this historic occasion but NOT made public.

However, if your event is open to the public your contact details will be shared with the media so that they can contact you direct to arrange any publicity and/or coverage of your event on 11th November 2018.

Name of Contact/Coordinator
Name of Council or Organisation
Job title of Coordinator
Full postal address including postcode
County
Country: England, Wales, Scotland, Northern Ireland, Channel Islands, Isle of Man, UK Overseas Territory
Telephone number - landline
Mobile number
Email Address
Beacon Location if known when registering, including postcode

Please ensure you have undertaken all the safety aspects etc, outlined on page 6 and before the lighting of your Bonfire Beacon on page 5 and you have alerted the emergency services, including the Fire Brigade, undertaken any risk assessments required and ensure all are happy with your plans. (This is your responsibility as coordinator of your Beacon lighting event).

Beacon Lighting Ceremony - 7pm on 11th November 2018

The Beacon lighting ceremony should be undertaken as follows:

Step 2: Invite your Lord Lieutenant, DL, Lord Mayor, Mayor, High Sheriff, High Steward, Lord Provost, Chairman or Leader of the Council. However, you may wish to consider running a competition in partnership with your local media, with the winner having the honour of lighting your WWI Beacon of Light at 7pm that evening.

Step 3: Please arrange to have professional photographs taken during your event, and immediately after, please send NO more than TWO high quality, copyright-free photographs to brunopeek@mac.com including the name of the photographer, the Beacon location, including postcode, along with the name of the Council or Organisation.

Step 4: If appropriate, please use social media channels - Twitter, Facebook etc - to promote your event. On Facebook, post photographs of your Beacon lighting ceremony on the 11th November 2018.

Step 5: On 1st November 2018 we will be providing you with an outline Press Release for your use, so please localise it, providing as much or as little information as you wish regarding your event, along with your contact details before YOU send it to all areas of your local media to enable them to contact YOU direct.

Step 6: Before the lighting of your Beacon at 7pm you may wish to consider reading out the names of those from your City, Town or Parish etc killed in action, during WWI, in remembrance of the sacrifices made.



Bonfire Beacon, Killyleagh, County Down, Northern Ireland.



Beacon at Manor Farm, Strete, Devon, courtesy of Kate Gill, Stete Parish Council.



WWI Beacons of Light, your unique gas-fuelled Beacon

The Battle's Over Beacon is of lightweight construction and comes assembled and complete with the exception of the gas cylinders that will need to be purchased separately:

a) 400g disposable cylinder of propane, (Bullfinch No 1644, or equivalent) for the FirePower Torch used to light the Beacon. These can be purchased from many DIY stores or Builders Merchants.

b) One full 47 kg propane cylinder or 2 x 19 kg full cylinders are recommended to give a full flame for an hour. For longer periods of burning or with partially full cylinders you will need double the number of cylinders. These cylinders can be purchased from Flogas Britain Ltd by calling 0800 085 6225 quoting Gas Fuelled Beacons or by going to their website www.flogas.co.uk where you can either order your cylinder online or locate your nearest Flogas stockist. You may also



download a propane cylinder safety data sheet from the Flogas website (www.flogas.co.uk/safety).

The Gas-Fuelled Beacon package will contain the following:

- Burner unit with distinct design to commemorate the event - with the motif WWI 1914 18 round the circumference
- 2m high stand with an anchor for fixing to the ground
- 10m hose with the regulator for connecting to the gas cylinders
- FirePower Gas torch for lighting the burner (you will need a 400g disposable cylinder of propane for this - (see above))
- Spanner
- Leak detecting fluid
- Hose assembly and Y manifold to link 2 cylinders
- Lighting and safety instructions

The above items are packed into 2 strong cartons.

The tripod describes a circle area of about 1.32m diameter and the beacon has an extended height of about 2.15m.



The Beacon (and flame) are stable in the wind up to 30 mph. It is supplied with a ground anchor and rope for securing to the ground if this is possible, or else we would recommend the use of sand bags. Full instructions are provided for this. The Beacon must be supervised by 2 people at all times when lit and a fire extinguisher must be provided. It is important that the supervision should be undertaken by those who are competent and it is essential that a trial be undertaken before the event to ensure that everyone is fully trained and familiar with the operation.

See our website bullfinch-gas.co.uk for more details.

The price is £360 plus VAT including carriage within the UK Mainland. There will be an extra carriage charge for other areas.

To order please contact:

Bullfinch Gas Equipment, Kings Road, Tyseley, Birmingham, B11 2AJ.



Tel: 0121 765 2000

Fax: 0121 707 0995

Email: sales@bullfinch-gas.co.uk

Web: www.bullfinch-gas.co.uk

Payment by Bank Transfer, Credit/Debit Card or Cheque. Payment will not be asked for until the Beacon is about to be despatched. Last date to order to guarantee delivery by 1st November is 31st August 2018. However please enquire after this date for availability.



Gas fuelled Beacon, Berkley Castle, Gloucestershire, England.



WWI Beacons of Light, Beacon Brazier

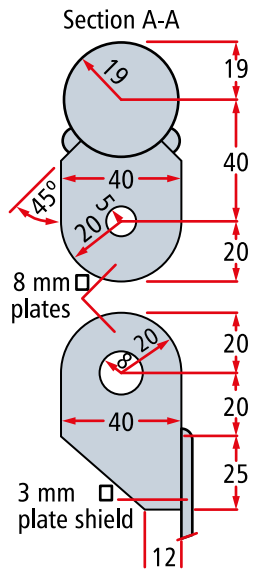
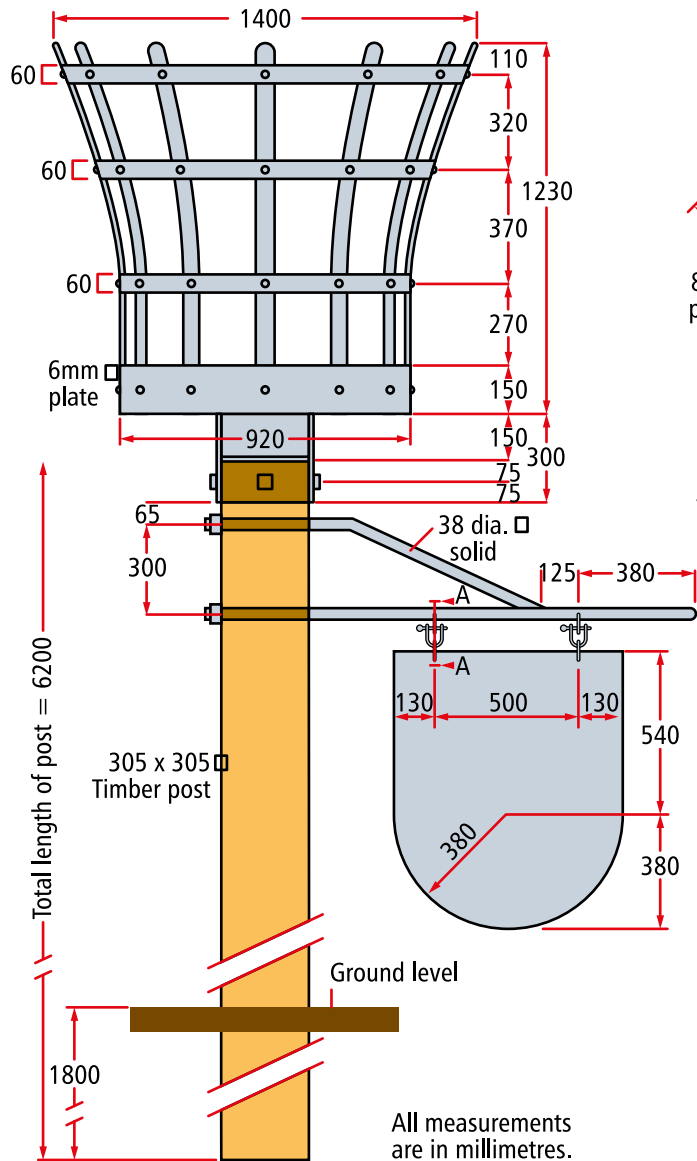

Beacon Brazier with Metal Shield

A Beacon Brazier can be a more permanent fixture, sited in a country park, hilltop or village green, as a lasting memorial of this important moment in history commemorated, and could be manufactured and erected by using local craftsmen.



Materials Required for Beacon Construction

Wooden centre post consisting of 305mm x 305mm wooden post, 6.25 metres in length of which 2 metres goes into the ground.

Basket and fixing brackets consisting of:

- 1 x 920mm diameter steel plate.
- 1 x 4,178 long 60mm x 5mm steel flat bar rolled into 1,330mm diameter ring.
- 1 x 3,455mm long 60mm x 5mm steel flat bar rolled into 1,100mm diameter ring.
- 1 x 2,985mm long 60mm x 5mm steel flat bar rolled into 950mm diameter ring.
- 1 x 2,922mm long 150mm x 5mm steel flat bar rolled into 930mm diameter ring.
- 12 x (approx 1,250mm long) 60mm x 5mm vertical bars (rolled to shape).
- 1 x 310mm x 310mm x 300mm high connection box welded to base of basket.
- 1 x hanging shield and support: 3.7m length of 38mm diameter solid steel rod.
- 1 x 920mm x 760mm steel plate 3mm thick 4 x connection brackets 8mm thick (see detailed drawings left).
- 2 x pins and loops.



WWI Beacons of Light Bonfire Beacon

Locate the bonfire at least 30m away from buildings, roads, railways and public rights of way, and a safe distance from dangerous materials and overhead power lines. Ensure it has good access for the transportation of materials for the bonfire and sufficient space for spectators to stand upwind.

Obtain the landowner's permission and involvement.

Liaise with local fire brigade and emergency services, presenting them with your plans, and seek their advice and support.

1 Prepare site by removing top layer of turf and stack away from fire area. Obtain seven poles, 5-6m in length. Attach four guy ropes to top of one pole and anchor as shown.

2 Erect remaining poles as shown, ensuring tops are secured in place.

3 Use either pallets or suitable lengths of timber, spreading them over ground area of beacon for a good through draught. Secure timber horizontally between poles as shown, preventing material placed over the framework from dropping through. Construct access

tunnel to the middle of the beacon. Keep middle empty until required. Always construct the bonfire so it collapses inwards as it burns.

4 Use only wood for combustible materials. Do not burn dangerous items such as foam-filled furniture, old tyres, aerosols or tins of paint. Build upwards until height of centre pole is reached. Materials around top should be loosely packed to allow air flow. Cover bonfire to keep it dry.

5 Fill centre with suitable, dry combustible materials. Check construction is stable and remove any unsuitable materials that may have been added. Look specifically for fireworks, aerosols, highly inflammable materials or containers with such materials.

6 Construct a safety barrier out of ropes and stakes or scaffold poles to ensure public is kept at a safe distance from the fire.

7 In daylight, and just before lighting, check that there are no children or animals playing or hiding in the bonfire. Arrange for, and brief sufficient numbers of marshals.

8 The person looking after the fire should not wear lightweight clothing that could ignite easily. They should wear a substantial outer garment of wool, or other material of

low flammability, and stout boots. They should know what to do in the event of a burn injury, or a person's clothing catching fire, and should have a fire blanket ready in the bonfire area along with a number of fire extinguishers.

9 Lighting: the safest and recommended approach is to use paper and solid firelighters in six places just inside the walls of the beacon to ensure an even burn. Never use flammable liquids such as paraffin or petrol to get it going as this can result in uncontrolled spread of fire or explosion.

10 To light the beacon: from poles 2m in length, prepare hand torches for lighting with paraffin-soaked rags wired around one end. Remember, paraffin is dangerous and great care should be taken. Paraffin can be used as directed, but it is still dangerous and should at all times be treated with great care - for example, always ensure all excess paraffin is drained off rags before use. If spilt on your clothes during the preparation of your beacon lighting you should replace those items of clothing before approaching any naked flames. In particular, always remember to replace the lid on any container of unused paraffin and store it in a safe place away from naked flames. Do not use an accelerant on the fire itself.



Bonfire Beacon, Shipston-on-Stour, Warwickshire, England.

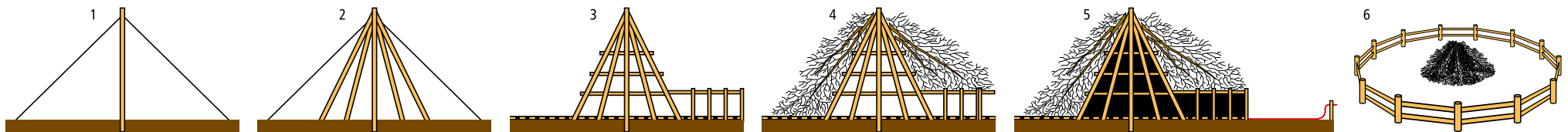

▲ After the event, extinguish fire and collect remaining debris. ▲ Dig over site and re-lay turf. ▲ Leave site clean and tidy.



Your responsibility, Legal Essentials and Safety

If you are inviting personal guests to your home it is worth checking with your household insurer that you are covered in the unfortunate circumstances that there should be an accident. If your event includes inviting the public, or it is a third party venue then, where applicable, the following advice should be heeded, to ensure you have a safe and enjoyable event for everyone involved.

Licensing

Your local authority is responsible for licensing of such events. This includes the sale of alcohol (please see separate section) and Regulated entertainment, which includes live and recorded music along with other types of entertainment. Generally if there are going to be no more than 499 people present at your event, including staff and performers you can apply for as Temporary Event Notice. This is a simple process and can be obtained from your local Council and completed on line for only £21. If you expect more than the 499 people you will require a Premises licence to allow your event to take place. This process takes at least 28 days after you have submitted your forms, so leave plenty of time, the process may seem complicated but you can get assistance from your local licensing service at the Council. Local authorities will treat each event individually. The licensing officer's job is to advise the local authority's licensing committee on the granting of a licence should anyone object. If there are no objections the licence will be granted but you may have to agree to some conditions. It is always worth checking before you apply with the Councils licensing service to see if location already has a licence, as some open spaces are already licensed. Talk to the licensing officer as soon as possible. In Northern Ireland, if you plan to sell alcohol at an event, you will need to apply for an occasional liquor license from the Northern Ireland Court Service.

Safety Advisory Groups

A lot of local authorities run Safety Advisory Groups for events, these groups consist of all emergency services plus other members such as the Highways authority. They can provide you with all the information you require and some have example event plans to assist you organising your events, you can normally contact them through your local Council or the Police events officers.

Insurance

Unfortunately accidents can happen at even the best organised events. Therefore you will need to consider and obtain insurance cover for your event, whether you are holding an event on your own premises or someone else's. Beacon/Bonfire events require specialist public liability cover. If you hire a park or venue or use land owned by a third party for your activity, they are likely to require you to have your own suitable insurance to cover your liability for any injury to the public or damage to other people's land or property. If hiring equipment for the event, you may need to insure these items; you may also need to consider cover for loss of any financial outlay you incur if the event has to be cancelled for reasons beyond your control, or loss of money, particularly if you are holding a fund-raising event. To help you obtain the appropriate insurance, and risk management advice, we are working closely with Unity Insurance Services, which is a specialist insurance broker in the voluntary and non-profit sector. They have developed a range of bespoke insurance covers specifically for the Beacon/Bonfire events. Unity is owned by a charity, The Scout Association, and donates all its profits back to charity. To obtain a quote or for more details or advice on the insurance cover you may need, please visit Unity's website, www.unityinsuranceservices.co.uk/beacons or telephone them on 0345 040 7702.



Alternatively, the licensing officer may be able to direct you to a suitable specialist company or broker, but you should not try to source this kind of insurance from a non-specialist.



Emergency Services

Tell the police well in advance about the type of event you are planning, and get in touch with your local community police officer. Write to the fire brigade and ambulance service, particularly if you are planning to have a Beacon/Bonfire, fireworks, or an event that will attract a large crowd. St John's Ambulance and the British Red Cross will provide first aid and sometimes a vehicle. You can be expected to be charged for these services. If your Council has a Safety Advisory group this process will be part of the process and will save time.



Food and Drink

Basic food hygiene guidelines should be followed at all times if you are providing food and drink. Caterers must have food hygiene certificates. Advice on this subject can be obtained from your local council environmental officer. If you are using outside catering companies check with your local authority to see if they are a registered food business.



Alcohol

If you wish to sell alcohol at your event you will need to obtain a licence, please see the section above on licensing, it is important that you obtain the correct permissions and your local authority Licensing service will help you do this. You can normally use a temporary events notice for a bar as only a small number of people can be present (less than the 499 limit).



Site Clearance

The local authority will arrange for clearance and disposal of litter after your event if it is on public ground (check for possible charges). You can help this process by arranging litter bins or recycling bins around the site, and a crew to clear up throughout the event.



Hiring or Borrowing Equipment

Your local authorities, or local event organisers may be able to help you with contacts for supplies such as marquees, portable toilets, barriers and bunting, or may in some cases have these for you to hire and borrow. You may also need to consider generators, a public address system, and emergency flood lighting. If you need to arrange insurance for your hired equipment, Unity Insurance Services can arrange this for you too. If you hire a Marquee make sure the company providing it provide you with the necessary safety certificates.



All Ability Access

Access for the disabled is very important. Many local authorities run community transport schemes. Talk to them about arranging transport. On green field sites access may be improved by cutting the grass before the event.



Message from the First Sea Lord Admiral Sir Philip Jones KCB ADC Chief of Naval Staff



Admiral Sir Philip Jones KCB ADC
First Sea Lord and Chief of Naval Staff

Images of trenches and barbed wire are an indelible part of our collective national memory, but the First World War also reached far beyond the Western Front. At sea, it stretched from the Battle of Jutland in the North Sea to the twin battles of Coronel and the Falklands in the South East Pacific and the South Atlantic Oceans, while to the east it spilled onto the beaches and clifftops of the Gallipoli Peninsula in Turkey. The lighting of Beacons will be an opportunity for families and communities around the country and overseas to remember their individual connections to these global events, and the many personal examples of courage and sacrifice.

As these Centenary commemorations draw to a close, the memory of those who fought in the First World War must never be extinguished. We must continue to learn the hard won lessons of this terrible war, because today, as was the case a century ago, our own national wellbeing is indivisible from the cause of peace and security in the wider world.



The Royal Naval Association is proud to be associated with 'Battle's Over - A Nation's Tribute'

With over 16,000 members across 300+ branches in the UK and overseas, we are a family of current and former Naval Service personnel, relatives and supporters of our country's Royal Navy.

Whether we are catching up with friends at our regular social events; fundraising; advising on welfare and employment matters, or just providing an arm around the shoulder, our natural willingness to help others stems from the tradition and camaraderie that only Naval Service life can instil. Everything we do is inextricably linked to our core values:

Unity

Shared backgrounds and equality in rank. We share the same bonds, the same mindset, and even the same language (Jackspeak!). We are all equal. We are the heart and soul of the RNA.

Loyalty

To each other and our dependants. We will always support and look out for each other. Our loyalty is to all our shipmates, our local communities, the personnel and dependants of the Naval Service, along with other charities or organisations with naval connections.

Patriotism

We are proud to serve and proud to represent our country and the Naval Service. Our pride in serving our country never leaves us. Nor do we forget those who have fallen for our country or who fight now. We are deeply honoured to represent them on both a national and international level.

Comradeship

Friends in fun, fellowship and need. Your shipmates will always be here for you, whether it's about a job, ideas for a fun day out or just an arm around the shoulder. We will never leave you or your dependants in despair.

The Royal Naval Association has lots of great things going on:

- Project Semaphore to bring digitally isolated naval veterans online.
- Befriending naval veterans who need an arm around the shoulder.
- 3 minibuses fitted with wheelchair hoist for socially isolated veterans.
- Support for those leaving the Royal Navy - the Shipmates and Oppos programme.
- We support and lead the Conference of Naval Associations, a group of 70 like-minded naval associations, bringing great benefits and working together. www.cona.org.uk/
- Most importantly we have fun together with our regular meetings and organised events - such as our annual reunion and Conference and the Remembrance Sunday march at the Cenotaph.

The RNA has been involved with many aspects of commemoration of the First World War.

- Our National Standard led the parade at the National Event at Lyness cemetery on the Orkneys for the Battle of Jutland, our members have been part of many events.
- We have lent the Chapel door of HMS WARSPITE to the National Museum of the Royal Navy - for their Jutland Exhibition running in Portsmouth from 2016 to 2020.
- We are the lead sponsor with the Woodland Trust in the establishment of the Jutland Wood as part of their WW1 Centenary Wood Project. The wood will consist of 6,094 trees - reflecting the number of Royal Navy sailors who lost their lives on that day in May 1916. The RNA has sponsored two of the large specimen trees in the main avenue, and hope to have members at the planning at Langley Vale Epsom in the Winter of 2017.

www.royal-naval-association.co.uk

RNA Central Office, Room 209, Semaphore Tower,
HM Naval Base, Portsmouth, PO1 3LT

admin@royalnavalassoc.com
02392723747

You can donate to the RNA at:
www.royalnavalassociation.co.uk/about-us/help-us/



ROYAL NAVAL ASSOCIATION

Message from General Sir Nicholas Patrick Carter KCB CBE DSO ADC Gen Chief of the General Staff

The Beacons of Light Tribute is a poignant reminder of the darkness brought by war so evocatively captured in Sir Edward Grey's quote from 1914.

"As the lights go out and the beacons are lit it is timely to reflect on what we might learn from our forefathers' experiences. We owe it to those who have gone before us to help the younger generation, further removed by time from war, to see beyond the mud and the blood and the casualties. We might learn about national resilience and community spirit, and in being prepared to fight the war we might have to fight, there is a much better chance of deterring that war from ever happening."



Nick Carter.

General Sir Nicholas Patrick Carter
KCB CBE DSO ADC Gen

Chief of the General Staff



ARMY



ABF The Soldiers' Charity is the National Charity of the British Army. Originally established as the Army Benevolent Fund in 1944, we provide a lifetime of support to soldiers, veterans and their immediate families in times of need.

How we help

We give financial assistance to individuals as well as make grants to a large number of specialist charities and partner organisations such as Combat Stress, SSAFA and the NSPCC, which provide support on our collective behalf.

The scope of our work is huge; from providing funding for specialist medical equipment for the 6-month old child of a serving soldier, to assisting with the care home fees of a 105-year-old veteran, our work touches the lives of around 80,000 people each year, sustaining the British Army 'family' both at home and around the world. We are The Soldiers' Charity: 'For Soldiers - For Life'.



How you can help

From abseils, skydives and 24-hour hikes across the Scottish wilderness, to cake sales, big curries and cycling challenges, there are many ways for you to get involved and support our work. However you choose to support us, your contribution will go a long way to making a difference to the lives of serving and veteran Army personnel, and their families.

We don't receive any statutory government funding, so we rely on the generosity of our supporters to ensure we can continue to be here, supporting the men and women of the British Army.

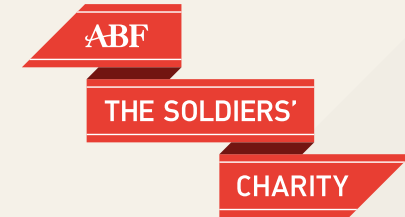

The Army's National Charity

For more information on The Soldiers' Charity or to make a donation, visit www.soldierscharity.org or email info@soldierscharity.org



facebook.com/soldierscharity



[@soldierscharity](https://twitter.com/soldierscharity)



instagram.com/soldierscharity

ABF The Soldiers' Charity is a registered charity in England and Wales (1146420) and Scotland (039189). Registered as a company limited by guarantee in England and Wales (07974609).

Registered Office: Mountbarrow House,
12 Elizabeth Street, London SW1W 9RB

Message from the Air Chief Marshal Sir Stephen Hillier
KCB CBE DFC ADC MA RAF
Chief of the Air Staff

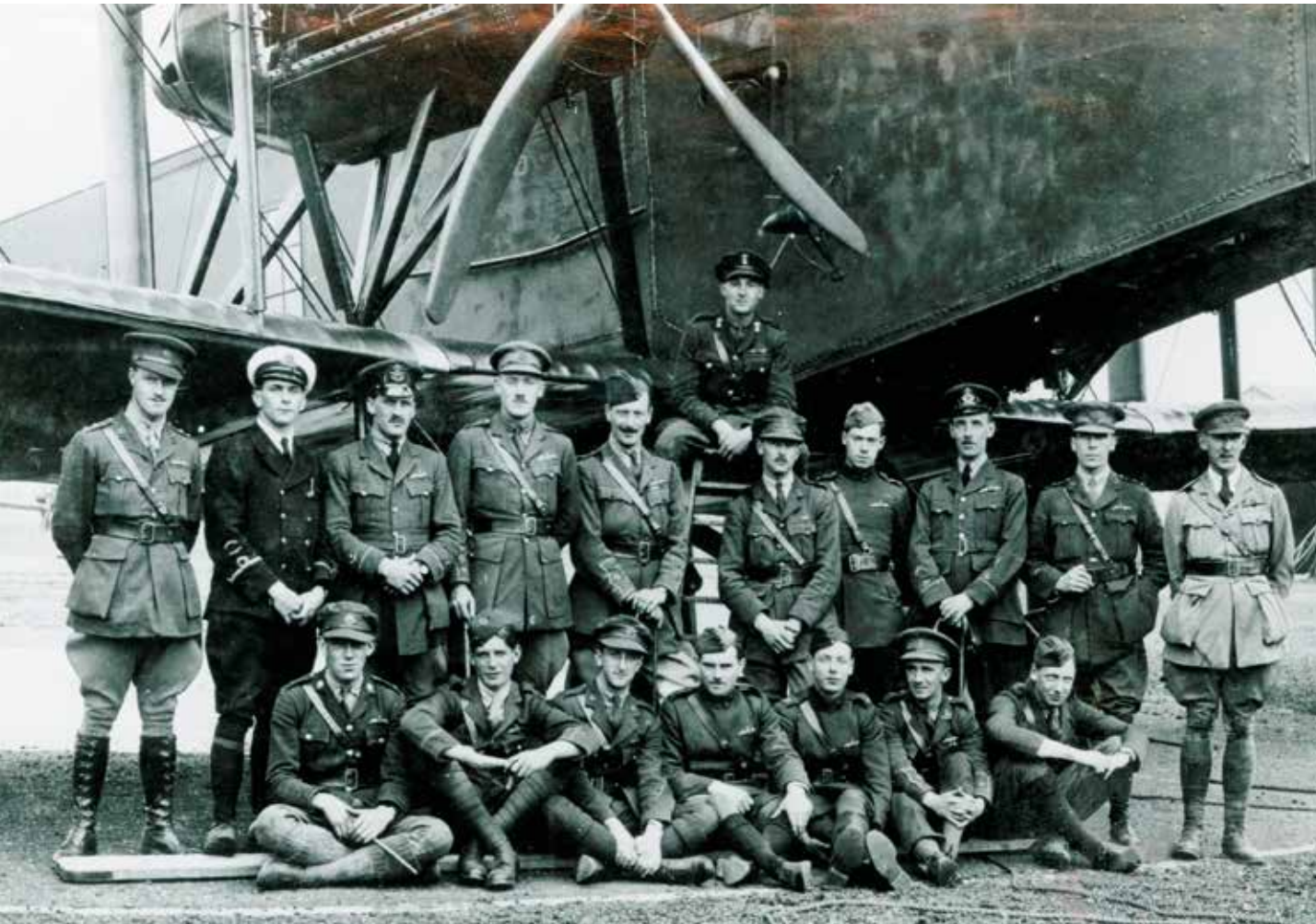

This Tribute will be supported across the length of the UK and the breadth of her overseas territories.

All of these communities made significant sacrifices in the seas, fields and skies during World War I, and this act provides the perfect opportunity to commemorate those hardships. And yet, the return of these beacons of light to the darkness reminds us of the hope which carried the Nation and her citizens through. That message of hope and inspiration is particularly apt in the centenary year of the birth of the RAF as the world's first independent air force, and I welcome the opportunity to reflect on both the grave losses and the incredible achievements which occurred during those dark years.

Air Chief Marshal
Sir Stephen Hillier
KCB CBE DFC ADC MA RAF

Chief of the Air Staff

 **ROYAL
AIR FORCE**



THE HEART OF THE RAF FAMILY SINCE 1919



**Royal Air Force
Benevolent Fund**
THE HEART OF THE RAF FAMILY



Since our foundation in 1919, the RAF Benevolent Fund has been there, through thick and thin, supporting the RAF family.

Our principal activities are to provide assistance to the RAF family when they are in need, maintain and preserve the RAF Memorial in London on behalf of the nation, support the morale and wellbeing of the serving RAF and be responsible for the Bomber Command Memorial in central London.

HOW WE HELP

We routinely help over 41,000 individuals every year, by providing a range of support aimed at serving and former RAF personnel. We also support members of the Air Cadet Organisation, including members of the Combined Cadet Force RAF component, if they are injured whilst on duty.

They include welfare breaks for families and veterans, grants to help with getting about inside and outside the home, specialist advice on benefits and care services, individual grants for RAF Stations and Station personnel and support for young people through our Airplay programme.

By working with others, we ensure that members of the RAF family get the right support, when it's needed. Last year we gave over £1m in external grants to over 50 charities and organisations including RAFA, SSAFA and the Royal British Legion.

HOW YOU CAN HELP

There are lots of ways you can get involved with the RAF Benevolent Fund and we always welcome your support.

And don't forget whatever you do, no matter how small, will go a long way in helping us make a difference to the lives of RAF personnel, past and present, and their families. From cake sales to fun runs, cycling challenges to dinners, your support matters.

We receive no regular government funding, so we rely entirely on people like you to continue our work supporting the men, women and children of the RAF family whenever they are in need.

For more information on the RAF Benevolent Fund or to make a donation, visit www.rafbf.org, or email info@rafbf.org.uk.



Message from Captain John Sail - National Chairman, The Merchant Navy Association



'Battle's Over' offers a wonderful opportunity to both record and remember what was endured and forgiven but not forgotten.

During the First World War attacks on merchant ships began slowly as the enemy sought to blockade Great Britain. In 1914 and 1915 a total of 342 ships and nearly 2,500 men, women and boys lost their lives with more being injured. During 1916 alone 396 ships and 1,217 seafarers lost their lives and if it were not for the introduction of the Convoy System, in 1917, many more merchant ships and their crews would have been lost and very likely the war as well. The Battle of the Atlantic was one of the most significant battles of that war and for the seafaring communities across the UK and overseas. We will remember them all now their 'Battle is Over'.

John Sail

Capt J M R Sail MNM MNI
MNA National Chairman

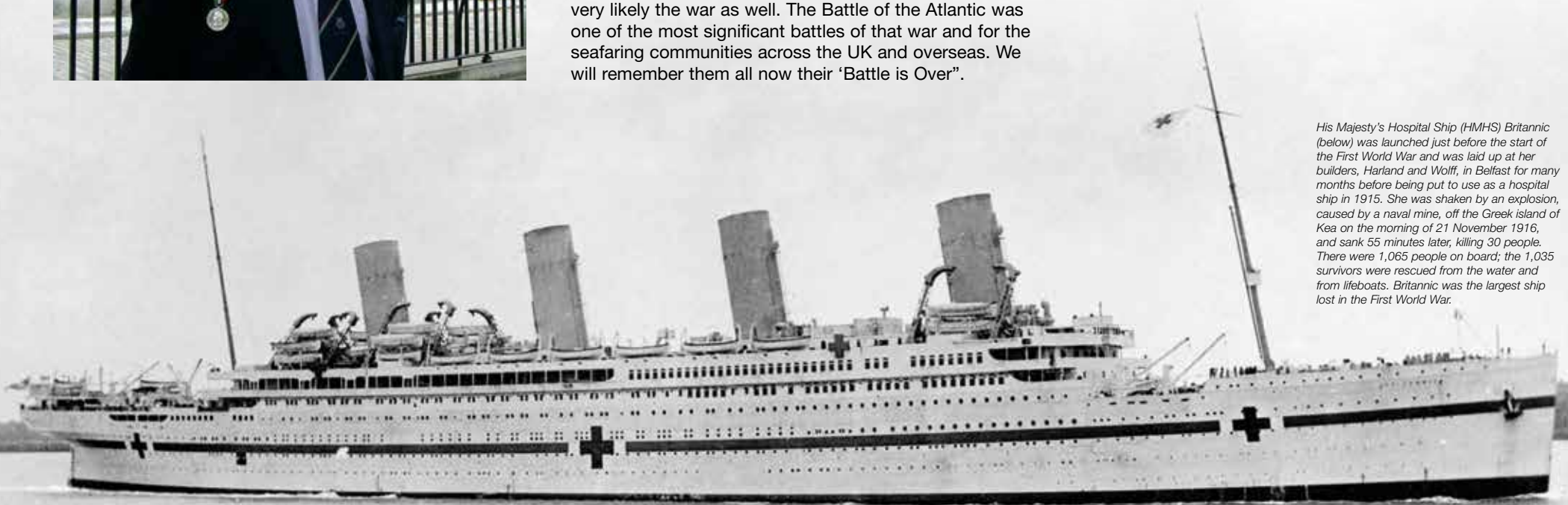

His Majesty's Hospital Ship (HMHS) Britannic (below) was launched just before the start of the First World War and was laid up at her builders, Harland and Wolff, in Belfast for many months before being put to use as a hospital ship in 1915. She was shaken by an explosion, caused by a naval mine, off the Greek island of Kea on the morning of 21 November 1916, and sank 55 minutes later, killing 30 people. There were 1,065 people on board; the 1,035 survivors were rescued from the water and from lifeboats. Britannic was the largest ship lost in the First World War.





The Merchant Navy Association

from ship to shore, from past to present

The merchantile marine, as it was termed in those times, played a significant and often critical role throughout the First World War...much the same as it would two decades later. In both world wars merchant seafarers and fishermen fought the enemy, the weather and the seas to keep the nation and the Armed Services supplied and able to defend themselves. Their way of life and conditions of service were austere with seafarers often not returning home for over two years, some having been sunk, survived and transferred to other ships to maintain those lines of support.

During the First World War attacks on merchant and fishing vessels began quite slowly but increased significantly as the enemy sought to blockade Great Britain. In 1914 and 1915 a total of 342 merchant vessels were lost to enemy action with 2,471 men, women and boys losing their lives. During 1916 there were 396 ships and 1,217 seamen killed. In the following year, 1917, the losses were so severe that the ships being built could not match the number of ships being lost in action with six ships a day being sunk on some days. The loss of life was increasing significantly. It was so severe that if the rate of losses of ships and men had continued the war would have been lost. No food, no fuel, no wood, no arms and ammunition especially some of the 91 million shells that were eventually produced and transferred by sea. In that year 1,197 ships were sunk through enemy action and 6,408 seamen were lost at sea with their ships...their only grave the sea. The losses had to be decreased and this was achieved by the introduction of the Convoy System in 1917. In 1918 the impact of the actions in the previous year were clearly evident with 544 ships and 4,122 seamen lost.

The total recorded losses for the First World War were 2,479 ships and 14,287 seamen plus 675 vessels of the fishing fleet and 434 seamen. There were many more seafarers who died ashore and were not commemorated. They had to die at sea to be commemorated even when they were hospitalised because of their wounds. They were also off pay when their ships were sunk. They actually had to die at sea to be commemorated.

The men, women and boys who were lost at sea during the First World War included lads such as Redan Sydney Jeffries (aged 13) of Lowestoft, presumed drowned on 24th October 1917. Redan was a Cook aboard the fishing vessel Vanguard. More than twenty-nine Boy seamen aged only 14 lost their lives for their King and Country. At the other end of the scale were men long overdue for retirement who insisted on "doing their bit" and who paid the ultimate sacrifice. Men such as A.B. Patrick Casey, aged 73, killed when the S.S. Dotterel was sunk by a mine off the French coast on 29th November 1915....they were the forgotten heroes, their lines of support were never broken.

Capt J M R Sail MNM MNI, MNA National Chairman

**Please donate what you can, when you can,
as often as you can. Small donations will make a
big difference.**

**Contact www.mna.org.uk
and access the DONATE button.**

Battle's Over - A Nation's Tribute & WWI Beacons of Light

Chosen Charities

Please give generously to one or more of our four chosen charities for this unique, historic tribute to the many that either died or returned home dreadfully wounded defending our freedom during the four dark years of World War I.



**ROYAL NAVAL
ASSOCIATION**

Please donate at:
www.royal-naval-association.co.uk/about-us/help-us/



**Royal Air Force
Benevolent Fund**
THE HEART OF THE RAF FAMILY

Please donate at:
www.rafbf.org/ways-to-give

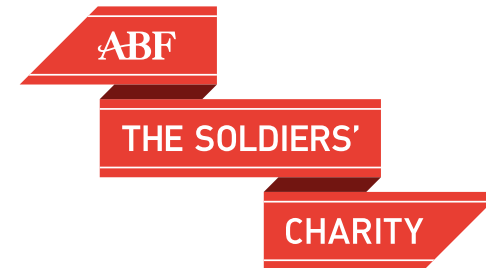

The Army's National Charity

Please donate at:
www.soldierscharity.org



The Merchant Navy Association

Please donate at:
www.merchantnavyfund.org



Battle's Over - A Nation's Tribute & WWI Beacons of Light Acknowledgements

This event is being organised in association with:

The Society of Editors, Army Cadet Force, Air Training Corps, Sea Cadet Corps, Combined Cadet Force, Association of English Cathedrals, Merchant Navy Association, Royal Naval Association, ABF The Soldiers' Charity, Royal Air Force Benevolent Fund, The Buglers Association of The Light Division & Rifles, Trinity House, National Association of Local Councils, National Association of Civic Officers, One Voice Wales, National Trust, English Heritage, Central Council of Bellringers, The College of Piping and the National Union of Mineworkers (formerly known as Miners Federation of Great Britain).
For further information relating to the Central Council of Church Bell Ringers, please visit: www.cccbr.org.uk

We would like to thank the many and various councils, churches, organisations, local communities, commercial companies, private land owners and others to date listed below, for their generous participation in this unique, local community tribute.

There are a number of others taking part as private occasions, so are not open to the general public so have asked not to be listed.

(The Merchant Navy Association will be lighting 12 further Beacons, the locations of which will be confirmed nearer the date).

ENGLAND

BEDFORDSHIRE

Leighton-Linslade Town Council
Silsoe Parish Council
Potton Town Council
Luton Borough Council
Billington Parish Council
Stanbridge Parish Council
Shefford Town Council
Millbrook Parish Meeting
Amphill Town Council, Amphill Armistice 100 Committee including The Royal British Legion, Army & Navy Cadets
Sandy Town Council
Stotfold Town Council

BERKSHIRE

Wraysbury Parish Council
Newbury Town Council
Slough Borough Council
Datchet Parish Council
Englefield Estate
Royal Borough of Windsor and Maidenhead & Crown Estate
Hungerford Town Council
Sunningdale Parish Council

Donnington Castle - (English Heritage)
Thatcham Town Council
Eton Town Council
Finchampstead Parish Council & St James's Church, Finchampstead

BUCKINGHAMSHIRE

The Parks Trust - Milton Keynes
Olney Town Council
Akeley Parish Council
Wolverton & Greenleys Town Council
Berryfields Parish Council
Stoke Poges Parish Council
Beaconsfield Town Council
Great Horwood Parish Council
Little Horwood Parish Council
Quainton Parish Council
Cublington Parish Council
Steeple Claydon Parish Council
Whaddon Parish Council

CAMBRIDGESHIRE

St Neots Town Council
Huntingdon Town Council
Chatteris Town Council
Eltisley Village

Warboys Parish Council
Cottenham Parish Council
Sawtry Parish Council
East Cambridgeshire District & City of Ely Council

CHESHIRE

Northwich Town Council
St Oswald's Church - Lower Peover
Beeston Parish Council & Beeston Castle
Alsager Town Council
Tushingham, Macefen & Bradley Parish
Winsford Town Council
Frodsham Town Council & Frodsham WWI Commemoration Working Group
Disley Parish Council
Little Budworth Parish Council
Wybunbury Parish Council
Beeston Castle - (English Heritage)
Malpas 100 Years On

CLEVELAND

Billingham Town Council

CORNWALL

St Michael's Mount (FAR WEST TIP OF ENGLAND)

Torpoint Town Partnership
Lizard Lighthouse - Trinity House
Pelynt Parish Council
St Mabyn Parish Council
Liskeard Town Council
St Stephens by Launceston Rural Parish Council
Penzance Town Council
Helson Town Council & Helston WWI Heritage Project
South Petherwin Parish Council
Madron Parish Council
Gwennap Parish Council
Marazion Town Council
Carn Brea Parish Council
Probus Parish Council
St Enoder Parish Council
Morval Parish Council
The Ruan Social Group (RSG)
St Cleer Royal British Legion - & other organisations
Rotary Club of Bodmin
Morwenstow Parish
Launceston Town Council
North Tamerton Parish Council
St Michael Penkivel Parish Council
Looe Town Council



Acknowledgements

COUNTY DURHAM

Brandon and Meadowfield Royal British Legion, Carrside Youth and Community Project and St. John's Hall, Meadowfield
Shotley Bridge Cricket Club
Ferryhill Town Council
Hartlepool Borough Council
Waldridge Parish Council
St Andrew's Church - Winston
Brandon & Byshottles Parish Council
Manfield with Cliffe Parish Council
Great Aycliffe Town Council
Barnard Castle Town Council
Spennymoor Town Council
Coxhoe Parish Council
Barnard Castle - (English Heritage)
Eggleston Parish Council

CUMBRIA

Brampton Parish Council
Provincial Grand Lodge of Cumberland and Westmorland Freemasons
Whitwell and Selside Parish Meeting
Mansergh Parish Meeting
Heversham Parish Council
Matson Ground Estate Co Ltd
Cumberland & Westmorland Freemasons
Windermere Lodge 2217
Windermere Town Council
Torver Parish Council
Coniston Parish Council
Dalston Parish Council
Milburn Parish Council
Muncaster Parish Council (3 Beacons)
West Cumberland Freemasons
Lamplugh and District Heritage Society & Lamplugh Young Farmers
Maryport Town Council
Scaleby Parish Hall Committee
Bootle Parish Council, Millom Without Parish Council and Whicham Parish Council

Bewcastle Parish Council
Dearham Parish Council
Millom Town Council
Blindbothel Parish Council
Carlisle Castle - (English Heritage)
Birdoswald Roman Fort - (English Heritage)
Castle Carrock & Geltsdale Parish Council

DERBYSHIRE

Erewash Borough Council (2 Beacons)
South Derbyshire District Council
Shardlow Church and Shardlow & Great Wilne Parish Council
Duffield Parish Council
Pilsley Parish Council
Northwood and Tinkersley Parish Council
Bradwell Parish Council
Aston-on-Trent Parish Council
Horsley Woodhouse Parish Council & Horsley Woodhouse Scout Group
Whaley Bridge Town Council
High Peak Borough Council
Chelmsorton Parish Council
Derbyshire & Lancashire Gliding Club
Pevelevil Castle - (English Heritage)
Dethick, Lea and Holloway Parish Council
Holymoorside & Walton Parish Council

DEVON

Blackborough Village
Bishopsteignton Parish Council
Delamore Estate
Lymptone Parish Council
Exeter City Council
Kings Nympton Community Group
Germansweek Parish
Start Point - Trinity House
Plympton & District Civic Society
Morcharde Bishop Parish Council
Buckland Brewer Parish Council
Crediton Town Council

Hennock Parish Council
Borough of Poole
Newton Abbot Town Council (3 Beacons)
Lifton Parish Council
South Tawton Parish Council
Okehampton Hamlets Parish Council
Chagford Parish Council
Strete Parish Council
Peter Tavy Parish Council
Newton Poppleford and Harpford Parish Council
Bideford Town Council
Clifford Estate Company Ltd & Chudleigh Town Council
Luppitt Parish Council
Burrington Parish Council
Holsworthy Town Council
Dawlish Town Council

DORSET

Portland Bill - Trinity House
Sturminster Newton Town Council
Bournemouth Council
Beaminster Town Council
Bere Regis Parish Council
Charmouth Parish Council
Borough of Poole
Bridport Town Council
Silton Parish Meeting
Ferdown Town Council, St Mary's Church & Ferdown Royal British Legion
Hambury Tout/The Lulworth Estate
Stratton (Dorset) Parish Council
Allington Hill, Cooper's Field and Wood Community Group

EAST & WEST SUSSEX

Crowborough Town Council
Community of Brightling Village
Wave Leisure Trust Ltd
Shining Lights (Bexhill Ltd)

Winchelsea Artefacts Society
Crawley Borough Council
1st Horam Scout Group & Horam Parish Council
Alfriston Parish Council
Burwash Parish Council
Northiam Parish Council
Hamsey Parish Council & East Chiltoning Parish Council
Willingdon and Jevington Parish Council
Milland Parish Council
Uckfield Town Council
Hooe Parish Council
Bognor Regis Town Council
Heathfield and Waldron Parish Council
Newick Parish Council with Newick Bonfire Society
Southbourne Sea Scouts
Littlehampton Town Council
Twineham Parish Council
Burgess Hill Town Council
Worthing Borough Council
Friends of Shoreham Fort

EAST YORKSHIRE

Rowley Parish Council
Sutton upon Derwent Parish Council
Market Weighton Town Council
Kilpin Parish Council
Hessle Town Council
Sancton All Saints Church PCC
Withernsea Town Council
Hedon Town Council
Beverley Town Council
Rawcliffe Parish Council
Bishop Buirton Parish Council
Withernsea Town Council
North Ferriby Parish Council
Skerne and Wansford Parish Council



Acknowledgements

ESSEX

Broxted Parish Council
White Colne Parish Council
Burnham-on-Crouch Town Council
Wivenhoe Town Council
Harwich Pier - Trinity House
St Lawrence Parish Council
Rochford District Council
Ingatestone and Fryerning Parish Council
Waltham Abbey Town Council
Harwich Society
High Easter Parish Council
St Lawrence PCC
Maldon District Council
West Bergholt Parish Council
Loughton Town Council
Billericay Town Council
Great Bentley Parish Council
Great Canfield Parish Council
Colchester Borough Council
Great Totham Parish Council
Margaret Roding Parish Council
Little Easton Parish Council
Ilford East Scout District
Alphamstone & Lamarsh Parish Council
Thaxted Parish Council
Thurrock Council & Coalhouse Fort

GLOUCESTERSHIRE

Girlguiding Gloucestershire
Wotton Under Edge & District Round Table
Stow on the Wold Town Council
Lydney Town Council
Cheltenham Trust & Cheltenham Town Hall
Wickwar Parish Council
Oldbury on Severn Parish Council
Windrush Parish Meeting
Adlestrop Village
St Edward's Evenlode PCC
Patchway Town Council
Siston Parish Council
Downend & Bromley Heath Parish Council

GREATER MANCHESTER

Stockport Metropolitan Borough Council
Tameside Council & Tameside Armed Services
Community
Manchester Cathedral
Bolton Council

HAMPSHIRE

East Meon Parish Council
Odiham Parish Council
Liss Parish Council
Candovers Parish Council
Portsmouth City Council
Bramley Parish Council
Damerham Parish Council
Denmead Parish Council
Hythe Marina Centre
West End Parish Council
Bishop's Waltham Parish Council
Hythe and Dibden Parish Council
Overton Parish Council
Hurst Castle - (English Heritage)
Porchester Castle - (English Heritage) in
association with Fareham Borough Council
New Milton Town Council, New Milton Lions &
Royal British Legion

HEREFORDSHIRE

Hereford City Council
Ross-on-Wye Town Council

HERTFORDSHIRE

Benington Recreation Ground Charity Trust
Hormeoad Community Group
St Stephen Parish Council
Highfield Park Trust
Stevenage Borough Council
Hertfordshire County Council
Shenley Parish Council
Perry Green and Green Tye Preservation
Society

Welwyn Hatfield Borough Council
St Albans City and District Council
Furneaux Pelham Hall
Woodcock Hill Village Green Committee
(WHVG)

ISLE OF WIGHT

St Catherine's Lighthouse, Southern Tip of the
Isle of Wight - Trinity House
The Royal British Legion - Isle of Wight
County Committee
Carisbrooke Castle - (English Heritage)

KENT

East Peckham Parish Council
Temple Ewell Parish Council
Hildenborough Parish Council
Canterbury City Council
Westenhanger Castle & Stanford Parish Council
8th Sheppey Scout Group
Dymchurch Parish Council
North Foreland - Trinity House
Petham Village
Yalding Parish Council
River Parish Council
Benenden Parish Council
Hawkhurst Parish Council
Chislet Parish Council
Rusthall Parish Council
Aldington and Bonnington Parish Council
Saint Peter and Saint Paul's Church -
Farningham
Snodland Town Council
St Nicholas-at-Wade & Sarre Parish Council
Lyminge Parish Council
Lydd Town Council
Hever Residents Association and Hever Parish
Council
Bidborough Parish Council
Broadstairs & St Peter's Town Council
10th Deal Eastry Scouts
Ashford Borough Council

Friends of Capel Church
Badlesmere Parish Hall
Great Chart Remembers - Great Chart
Eastry Parish Council
Tenterden Town Council
Birchington Parish Council
Borough Green Parish Council
Plaxtol Parish Council
New Romney Town Council
Hartlip Parish Council
Dover Town Council
Newchurch Parish Council
Woodnesborough Parish Council
Lamberhurst Parish Council
Chilham Parish Council
Egerton Parish Council
The Three Suttons and Sutton Valence &
District Branch RBL
Stockbury Parish Council
Hartley Parish Council
Detling Parish Council
Hoo St Werburgh Parish Council
Leeds Parish Council
Wye with Hinxhill Parish Council
Harrietsham Parish Council
Wickhambreaux Parish Council
Mersham and Sevington Parish Council
Westerham Town Council
Horton Kirby and South Darent Parish
Council
Staplehurst Parish Council
Westwell Parish Council
Newington History Group - Newington
Dover Castle - (English Heritage)
Longfield and New Barn Parish Council
Appledore Local History Society
Teston Parish Council
Cranbrook & Sissinghurst Parish Council
Cliffe and Cliffe Woods Parish Council
Ash-cum-Ridley Parish Council
Crundale Parish Council
Folkestone Town Council



Acknowledgements

LANCASHIRE

Staining Parish Council
Earby Town Council
West Lancashire Borough Council
Whittington Parish Council
Wyre Council
Chorley Council
Fylde Borough Council
Lancaster City Council
Pilling Parish Council
Duchy of Lancaster - Lancaster Castle & Lancaster City Council
Whitworth Town Council
West Bradford Parish Council
Grindleton Parish Council
Bretherton Parish Council
Bold Parish Council
Ribby with Wrea Parish Council & Westby with Plumpton Parish Council
Little Ecclestone and Larbreck Parish Council
Preesall Town Council
Slaidburn & Easington Parish Council
Warton Parish Council
Whittle-le-Woods and Clayton-le-Woods War Memorial Committee
Mellor Parish Council
Whittle-le-Woods Parish Council
Catforth Village Memorial Hall
Rochdale Borough Council

LEICESTERSHIRE

Husbands Bosworth Parish Council
Leicestershire County Council
Fleckney Parish Council
Great Easton Parish Council
Broughton Astley Parish Council
Ashby de la Zouch Town Council
Thorpe Acre Scout Group
Barkby and Barkby Thorpe Parish Council
Earl Shilton Town Council

Hinckley and Bosworth Borough Council
Breedon on the Hill Parish Council
Twyford Recreation Ground
Glenfield Parish Council

LINCOLNSHIRE

International Bomber Command Centre
Worlaby Parish Council
Hibaldstow Parish Council
Elsham Parish Council
Corby Glen Parish Council
Haxey Parish Council
Pinchbeck Parish Council & St. Mary's Church
Deeping St James Parish Council
Stapleford Parish Meeting
Metheringham, Sots Hole and Tanvats Parish Council
Epworth Town Council
Scopwick and Kirkby Green Parish Council
Scrivelsby Estate
North East Lincolnshire (3 Beacons)
Louth Town Council
Barrowby Parish Council
Crowland Parish Council
Collyweston Parish Council
Elsham Parish Council

LONDON

Merchant Navy Association National Memorial - Tower Hill, London
Royal Borough of Greenwich (3 Beacons)
Barnet Borough Scouts
London Borough of Havering
Ealing Council
London Borough of Islington
London Borough of Camden

MERSEYSIDE

Billinge Chapel End Parish Council
Cronton Parish Council

NORFOLK

Thorpe St Andrew Town Council
Potters Leisure Resort
Melton Constable Parish Council
Cromer - Trinity House
The Greyhound Inn - Hickling
Shouldham Parish Council
Ashill Parish Council
Norfolk Tank Museum
Lingwood and Burlingham Parish Council
Wells Harbour Commissioners
Honing Village Hall
Thetford Town Council
Claxton Parish Council
Letheringsett with Glandford Parish Council
Wiveton Parish Council
Downham Market Town Council
Ashwellthorpe and Fundenhall Parish Council
Overstrand Parish Council
Necton Parish Council
Marshland St James Parish Council
Walpole Cross Keys Parish Council
Barton Bendish Parish Council
Swanton Novers Parish Council
Langham Parish Council
Norwich City Council
Great Yarmouth Borough Council
Rollesby Parish Council
Blakeney Parish Council
Surlingham Parish Council
Dersingham Parish Council
Attleborough Town Council
Garvestone, Reymerton & Thuxton Parish Council
Hockham Parish Council
Wood Norton Parish Council
Beeston Regis Parish Council
Repps with Bastwick
Chedgrave Parish Council
Hoveton Parish Council
Hardingham Parish Council and Village Hall Committee

Acle Bridge Inn, Acle
Great Massingham Parish Council
Tittleshall Parish Council
Norfolk District Council
Heacham Parish Council
Stoke Ferry Parish Council
Dickleburgh & Rushall Parish Council
Northrepps Parish Council
Fincham Parish Council
West Dereham Parish Council
Broome Parish Council
Morston Parish Council
North Norfolk District Council & Cromer Town Council
Kelling Parish Council
Fakenham Town Council
Sheringham Town Council
Hardingham Parish Council

NORTHAMPTONSHIRE

Thrapston Town Council
Corby Borough Council
Little Addington Parish Council
Raunds Town Council
Farthinghoe and Steane Parish Council
Brackley Town Council
Irthlingborough Town Council
Northamptonshire County Council & All Saints' Church
Crick Parish Council
Grendon Parish Council
Harlestone Parish Council
Duston Parish Council
Cogenhoe and Whiston Parish Council
Litchborough Parish Council
Cold Higham Parish Council
Whittlebury Parish Council
Helmdon Parish Council
Bozeat Parish Council
Denton Parish Council



Acknowledgements

NORTHUMBERLAND

Heugh Hill (Holy Island) - Trinity House
Morpeth Town Council
Amble Town Council
Ford & Etal Estates with the North
Northumberland Branch of The Royal British Legion
Lindisfarne Priory - (English Heritage)
Housesteads Roman Fort - (English Heritage)
Berwick-upon-Tweed Barracks - (English Heritage)

NORTH YORKSHIRE

Richmond Town Council
West Tanfield Committee
Danby Beacon Trust
Bentham Town Council
Masham Parish Council
Spofforth with Stockeld Parish Council
Skipton Town Council
Bewerley Parish Council
Tadcaster Town Council
Tan Hill Inn (HIGHEST PUB IN GREAT BRITAIN)
Barlby and Osgogby Town Council
Leavening Parish Council
Settle Town Council
Goldsborough Hall
Willerby Parish Council
Riccall Parish Council
Dalton on Tees Parish Council
Gateford Parish Council
Langthorpe Parish Council
Wistow Parish Council
Askham Richard Parish Council
Rudby Parish Council
Burton in Lonsdale Parish Council
Whitley Parish Council
Escrick Parish Council
Sherburn Parish Council
Clapham cum Newby Parish Council

Eskdaleside cum Ugglebarnby Parish Council
Knaresborough Town Clerk
Scagglethorpe Parish Council
Baldersby & Baldersby St James Parish Council
Great Ayton Parish Council
Darley & Menwith Parish Council
Settringham Parish Council
Long Preston Parish Council
Rawcliffe Parish Council
Middleham Town Council
Thirsk Royal British Legion in association with the Rotary Club of Thirsk
Scarborough Castle - (English Heritage)
Richmond Castle - (English Heritage)
Whitby Abbey - (English Heritage)
Pickering Castle - (English Heritage)
Middleham Castle - (English Heritage)
Rocliffe & Westwick Parish Council
Sneaton Village Community in association with Beacon Farm, supported by Sneaton Parish Council
Tanfield Parish Council
Bilbrough Parish Council
Easingwold Town Council
Upper and Nether Poppleton Parish Councils
Copmanthorpe Parish Council

NOTTINGHAMSHIRE

Nottingham City Council
Kimberley Town Council
Clarborough and Welham Parish Council
Flintham Parish Council
Costock Parish Council
Bunny Parish Council
Wysall Parish Council
Willoughby on the Wolds Parish Council
Elston Parish Council
Collingham Parish Council
Nottingham City Council
Normanton on the Wolds Parish Council

Shelford Parish Council - Nottinghamshire
Plumtree Parish Council
East Stoke Parish Council
Whatton in the Vale Parish Council
Thurgarton Parish Council
Stanton on the Wolds Parish Council
East Markham Parish Council

OXFORDSHIRE

Wootton Memorial Playing Field Committee
Abingdon-on-Thames Town Council
Swinbrook & Widford Parish Council
Upper Lea Farm
Vale of White Horse & Faringdon Town Council
Brightwell Baldwin Parish Meeting
Lockinge Estate with Ardington & Lockinge Parish Council
The Bix Branch of The Royal British Legion
Greatworth Parish Council
Swyncombe Parish Council
Banbury Town Council
Thame Town Council
Clanfield Festival

RUTLAND

Rutland County Council
Barrowden

SHROPSHIRE

Clive Parish Council
Burwarton Estates
Sibdon Parish Meeting
Whixall Parish Council
Cound Parish Council
Ightfield and Calverhall Parish Council
Much Wenlock Town Council
Bayston Hill Parish Council & Bayston Hill Scouts
Lights Out Trefonen
Ruyton XI Towns Parish Council

SOMERSET

North Somerset Council
Sedgemoor District Council
AH Trollope-Bellew
Long Ashton Community Association Somerset
Peasedown St John Parish Council
Kingsdon Parish Council
Everard Family - Broford Farm
Trull Parish Council
Midsomer Norton Town Council
Cucklington Parish Meeting
Williton Parish Council
Priddy Parish Council & Priddy Friendly Society
Chard Town Council
Clatworthy Parish Council
Priston Parish Council
St Cuthbert (Out) Parish Council
Ilminster Town Council
Dunkerton & Tunley Parish Council
Uphill Village Society
Banwell Parish Council
Stawell Village Hall Committee

SOUTH YORKSHIRE

Tickhill Town Council
Hunshelf Parish Council
Charles & Rosalind Buckler
Tankersley Parish Council
Sheffield Vulcan Rotary Club
Hellaby Parish Council
Austerfield Parish Council
Penistone Agricultural Show
Wales Parish Council
Burghwallis Parish Council
Sykehouse Parish Council
Brinsworth Parish Council
Wadworth Village Hall Committee
Conisbrough Castle - (English Heritage)
Armthorpe Parish Council
Fwd Martha's Yard Hoylands Community Garden



Acknowledgements

STAFFORDSHIRE

Lichfield City Council
Cheddleton & Wetley Rocks Parish Council
Parish of Quinton & Admington
Endon with Stanley Parish Council
Cannock Chase Council
Stone Town Council
Rugeley Town Council
Loggerheads Parish Council
Kingsley Parish Council
Dilhorne Recreation Centre
Hixon Millennium Green Trust
Croxden Parish Council
Bishops Offley Millennium Green Trust
Colwich Parish Council

SUFFOLK

West Row Village War Memorial, West Row
Bures St Mary Parish Council & Bures Royal
British Legion
Dukes Head - Somerleyton
Levington and Stratton Hall Parish Council
Orford & Gedgrave Parish Council
Mendlesham Parish Council
Sudbury Town Council
Nacton Community Council
Waveney District Council
Little Thurlow and Great Thurlow Parish
Councils
Friston Parochial Church Council
Ipswich Borough Council
Metfield Parish Council
Alderton Parish Council
Burstall Parish Council
Sproughton Parish Council
Holton St Mary Village
Barnham Parish Council
Beccles Town Council
Kedington Parish Council and Kedington &
District Branch Royal British Legion
Haverhill Town Council

Aldeburgh Town Council
Glemham Hall Events & Little Glemham Parish
Council
Woodbridge Town Council
Laxfield Parish Council
Cockfield Parish Council
Woolverstone Village with Woolverstone
Parish Council & Ipswich High School for Girls
Great Bealings Parish Council
Bungay Town Trust
Woolpit Parish Council
Boxford Community Council
Kirton & Falkenham Parish Council
Beck Row, Holywell Row & Kenny Hill Parish
Council
Whepstead Community Association
Benhall & Sternfield Parish Council
Clare Community Association (CCA)
Brent Eleigh Parish Council
Badingham Parish Council
Capel St Mary War Memorial Trust
Hepworth Parish Council
Rushmere St Andrew Parish Council
Norton Parish Council
Kettlebaston Parish Council
Hitcham Parish Council
Wissett Parish Council with Wissett
Community Council & Church Councils
Great Ashfield Parish Council
Kesgrave Town Council
Combs Parish Council
Melton WWI Heritage Group
Great and Little Wheltenham Parish Council
Henley Parish Council/Henley Community
Centre

SURREY

Farnham Castle
Caterham Festival Committee
West End Parish Council
Normandy Parish Council

Guildford Borough Council & Guildford Lions
Clubs
Reigate and Banstead Borough Council
Worplesdon Parish Council
Royal British Legion (Pirbright Branch)
Lingfield Parish Council
Dormansland Parish Council
Cranleigh Parish Council

TYNE AND WEAR

Tynemouth Priory

WARWICKSHIRE

Royal Leamington Spa Town Council
Stratford-upon-Avon Town Council &
Stratford-upon-Avon District Council
Snitterfield Parish Council
Fillongley Parish Council
Harbury Parish Council
Bishop's Itchington Parish Council
Salford Priors Parish Council
Hepkrow Parish Council
Coleshill Town Council
Ansty Parish Council
Budbrooke Parish Council
Leek Wootton & Guy's Cliffe Parish Council
Wolvey Parish Council
Upper and Lower Quinton

WEST MIDLANDS

St Stephen's Church - Rednal
Birmingham City Council
Solihull Metropolitan Borough Council
St. Peters Collegiate Church - Wolverhampton
Wythall Community Association

WEST YORKSHIRE

Wakefield Metropolitan District Council
Strathmore/Blackshaw Parish
Hebden Royd Town Council
Clifford Parish Council

Hemsworth Town Council
Emley Millennium Green
Normanton Town Council
Collingham with Linton Parish Council
Kippax British Legion & Kippax Parish Council
R&CP Haigh and Sons
Barwick in Elmet Parish Council
Scholes Parish Council
Woolley Village Residents Association
Baldon Town Council

WILTSHIRE

Manorial Court for the Hundred & Borough of
Cricklade
Steeple Ashton Bellringers
Semington Village
Sutton Benger Village Hall & Recreation
Ground Charity
Westbury Town Council
Stanton Saint Bernard Parish Council
Amesbury Town Council
Stratton St Margaret Parish Council
Stonehenge - (English Heritage)
Compton Bassett Parish Council
Coberley Parish Council

WORCESTERSHIRE

Worcestershire County Council
Severn End Estate
Ripple Parish Council & Great Mongeham
Parish Council
Hindlip, Martin Hussingtree & Salwarpe Parish
Council
Romsley Parish Council
Kempsey Parish Council
Overbury Enterprises
Rock Parish Council
Hanley William, Hanley Broadheath & Hanley
Childe Parish/Edward Yarnold
Clent Parish Council



Acknowledgements

CHANNEL ISLANDS & ISLE OF MAN

SARK
STATES OF ALDERNEY
STATES OF GUERNSEY
STATES OF JERSEY

ISLE OF MAN

Isle of Man Government
Isle of Man Civil Defence

NORTHERN IRELAND

St Macartin's Cathedral (MOST WESTERLY CATHEDRAL IN THE UNITED KINGDOM)
Antrim and Newtownabbey Borough Council (2 Beacons)
Ards and North Down Borough Council (3 Beacons)
Armagh City, Banbridge and Craigavon Borough Council
Mid & East Antrim Borough Council
Lisburn & Castlereagh City Council

SCOTLAND

Aberdeen City Council
Argyll Estates
West Lothian Council
North Ayrshire Council
The Royal Burgh of Annan Community Council & Annan Branch of the Royal British Legion
Renfrewshire Lieutenancy
Unst Community Council (MOST NORTHERLY INHABITED ISLAND IN THE UK)
The National Trust for Scotland
Colpy/Culsalmond (Williamston Estates)

Clackmannanshire Council
Meldrum and Bourtie Community Council
Old Rayne Community Association
Cringletie Farm
Culross Community Council
Royal Naval Association Rosyth & West Fife Branch
Port William Community Association Scio
Legion Scotland Hawick Branch

WALES

St Davids City Council (THE MOST WESTERLY CITY IN WALES)
Amroth Village / Amroth Arms
Mumbles Community Council
St Anne's Head - Trinity House
Newport City Council
St Mary Hill Church
Carmarthen Town Council
Llangynidr Beacon Committee
Wrexham County Borough Council
Cowbridge with Llanblethian Town Council
Beaumaris Town Council
Welshpool Town Council (2 Beacons)
Magor with Undy Community Council
Fishguard and Goodwick Town Council
Menai Bridge Town Council
Penhow Community Council
Martletwy Community Council
Llandefalle Hall Committee
Penally Community Council
Pembrey and Burry Port Town Council
Usk Town Council
Portskewett Community Council
Whitton Community Council
Caernarfon Royal Town Council
Narberth Town Council
Llansteffan and Llanybri Community Council

Saundersfoot Community Council
Montgomery Town Council
Rhayader Town Council
Langstone Community Council
Llanwenog Community Council
Rhuddlan Town Council
Bridgend Town Council
Cyngor Cymuned Dolbenmaen (Dolbenmaen Community Council)
Llantwit Major Town Council
Shirenewton Community Council (Monmouthshire)
Dyffryn Cennen Community Council
The Havens Community Council
Cyngor Tref Criccieth Town Council
Abergwyngregyn Village, Gwynedd
Llanfair Clydogau Village Hall Committee
Llanfihangel Rhydithon Community Council
Mawr Community Council
Abergavenny Town Council
Abetillery and Llanhilleth Community Council
Aberporth Community Council
Haverfordwest Town Council
Cyngor Tref Tywyn/Tywyn Town Council
Fairfield Farm, Powys
Llandudno Town Council - Conwy
St Chads Church - Wrexham
Girlguiding Caernarfonshire
Amroth Community Council
Machynlleth Royal British Legion - Powys
Marloes Community Council - Pembrokeshire
Neyland Town Council
Llanelwedd Community Council
Amlwch Group, Battle's Over
Crynant Community Council
Gwersyllt Community Council

UNITED KINGDOM OVERSEAS TERRITORIES

Government of South Georgia & South Sandwich Islands
St Helena - South Atlantic Ocean
Ascension Islands Government
Falkland Islands Council
Tristan da Cunha
Government of the Virgin Islands
Government of Bermuda
Pitcairn Island



Sleep in Peace, now the Battle's Over

Acknowledgements

We would very much like to thank all of those that have helped make this aspect of 'Battle's Over' a reality.

Participating Cathedrals, Minster Churches and others.

ENGLAND

Bath

Bath Abbey
Bristol & Gloucester Wing, Air Trains Corps

Blackburn

Blackburn Cathedral
Acrington Pipes and Drums (The oldest Pipe Band in the World)

Birmingham

Birmingham Cathedral
West Midlands Fire Service Pipe Band

Bradford

Bradford Cathedral
City of Bradford Pipe Band

Bristol

Bristol Cathedral
Royal Marines Reserve
Name of Piper: Piper Robert Cunningham

Brighton and Hove

St Nicholas Church
Sussex Wing, Air Training Corps

Bury St Edmunds

The Cathedral Church of St James and St Edmund
Norfolk & Suffolk Wing, Air Training Corps

Cambridge

King's College Chapel
Cambridgeshire Caledonian Pipe Band

Canterbury

Kent Wing, Air Training Corps

Carlisle

Carlisle Cathedral
Army Cadet Force

Chelmsford

Chelmsford Cathedral
Name of Piper: Jonathan Swan (Member of the congregation)

Chester

Chester Cathedral
Army Cadet Force

Chichester

Chichester Cathedral
Army Cadet Force

Coventry

Coventry Cathedral
Shirley Pipe Band
Name of Piper: Dr Rodger Patrick BA

Derby

Derby Cathedral
Army Cadet Force

Durham

Durham Cathedral
Air Training Corps

Ely

Ely Cathedral
RAF Waddington Pipes and Drums

Exeter

Exeter Cathedral
City of Exeter Pipes and Drums

Gloucester

Gloucester Cathedral
St Andrew's Pipe Band of Cheltenham

Great Yarmouth

Great Yarmouth Town Hall
Air Training Corps

Guildford

Cathedral Church of the Holy Spirit
Guildford Cathedral
Gordons School Combined Cadet Force

Hereford

Hereford Cathedral
Professor Alan Harrison

Kingston upon Hull

Holy Trinity Church
Beverley and District Pipe Band

Lancaster

St Peter's Catholic Cathedral
Army Cadet Force

Leeds

Cathedral Church of St Anne
City of Leeds Pipe Band

Leicester

Leicester Cathedral
RAF Waddington Pipes and Drums

Lichfield

Lichfield Cathedral
Piper Stuart Maclaughlan

Lincoln

Lincoln Cathedral
RAF Waddington Pipes and Drums

Liverpool

Liverpool Cathedral
Liverpool Clan Wallace Pipe Band
Name of Piper: Pipe Major Robbie Blackmore
(Will be 70 year's old in 2018)

London

St Paul's Cathedral, City of London
Sussex Wing, Air Training Corps

Westminster Abbey, Westminster, London
Sussex Wing, Air Training Corps



Acknowledgements

The Queen's Chapel of the Savoy, Savoy Hill,
Strand, London
Sussex Wing, Air Training Corps

RAF Memorial, Victoria Embankment, Victoria,
London
Sussex Wing, Air Training Corps

National Merchant Navy Memorial, Trinity
Square Gardens, Tower Hill, London
Sea Cadet Corps

Manchester

Manchester Cathedral
Name of Piper: Piper Neil MacDonald

Norwich

Norwich Cathedral
City of Norwich Pipe Band
Name of Piper: Piper David Harper

Newcastle Upon Tyne

St Nicholas Cathedral
North Tyneside Pipe Band

Nottingham

Cathedral Church of St Barnabas
RAF Waddington Pipes and Drums

Oxford

Christ Church
Oxford Caledonian Pipes and Drums
Name of Piper: Piper H. P. Smith

Peterborough

Peterborough Cathedral
Peterborough Highland Pipe Band

Plymouth

Plymouth Catholic Cathedral
Sea Cadet Corps

Portsmouth

Portsmouth Cathedral
Hampshire Caledonian Pipe Band

Preston

The Minster and Guild Church of St John the
Evangelist
City of Preston Pipes and Drums

Ripon

Ripon Cathedral
CE Yorkshire Wing, Air Trains Corps

Rochester

The Cathedral Church of Christ and the
Blessed Virgin
City of Rochester Pipe Band
Name of Piper: Piper Major Tony Daniel

Salford

Church of St John the Evangelist

Salisbury

Salisbury Cathedral
RAF Waddington Pipes and Drums

Sheffield

The Cathedral Church of St Peter and St Paul
City of Sheffield Pipe Band

Southampton

Hampshire Caledonian Pipe Band

Stoke on Trent

Stoke Minster

St Albans

St Albans Cathedral

Sunderland

Sunderland Minster

Truro

Truro Cathedral
RAF Waddington Pipes and Drums
Army Cadet Force

Wakefield

Wakefield Cathedral

Wells

Wells Cathedral

Winchester

Winchester Cathedral
Hampshire Caledonian Pipe Band

Wolverhampton

St Peter's Collegiate Church

Worcester

Worcester Cathedral

York

Mansion House, St Helen's Square
RAF Waddington Pipes and Drums

SCOTLAND

Aberdeen

St Mary's Catholic Cathedral
The National Youth Pipe Band of Scotland

Dundee

St Paul's Cathedral
The Mackenzie Caledonian Pipe Band
Name of Piper: Piper Major Neil Nicholson

Edinburgh

St Mary's Episcopal Cathedral
The National Youth Pipe Band of Scotland

Glasgow

Glasgow Cathedral
The National Youth Pipe Band of Scotland

Holyrood

Church of the Holyrood
South East Wing Air Training Corps

Inverness

St Andrew's Cathedral
1st Battalion the Highlanders
Name of Piper: Pipe Major Calum Mackenzie

Perth

Perth Cathedral, St Ninian's
The National Youth Pipe Band of Scotland

Stirling

Church of the Holy Rude

WALES

Cardiff

Cardiff Metropolitan Cathedral of St David
Army Cadet Force

Newport

St Woolos' Cathedral
Newport Cathedral
Army Cadet Force

St Davids

St Davids Cathedral
Army Cadet Force

Swansea

St Joseph's Cathedral
Army Cadet Force



Acknowledgements

NORTHERN IRELAND

Armagh

Cathedral Church of St Patrick
1st and 2nd Battalion Army Cadet Force (N.I.)

Belfast

St Anne's Cathedral
1st and 2nd Battalion Army Cadet Force (N.I.)

County Down

Cathedral Church of the Holy Trinity, 1st
Battalion Army Cadet Force (N.I.)
Cathedral Church of Christ the Redeemer, 1st
& 2nd Battalion Army Cadet Force (N.I.)

Derry

St Columb's Cathedral
1st and 2nd Battalion Army Cadet Force (N.I.)

Downpatrick

Cathedral Church Of The Holy Trinity
1st and 2nd Battalion Army Cadet Force (N.I.)

Dromore

Cathedral Church Of Christ The Redeemer
1st and 2nd Battalion Army Cadet Force (N.I.)

Enniskillen

St Macartin's Cathedral
1st and 2nd Battalion Army Cadet Force (N.I.)

Lisburn

Cathedral of Christchurch
1st and 2nd Battalion Army Cadet Force (N.I.)

Newry

1st and 2nd Battalion Army Cadet Force (N.I.)

ISLE OF MAN

Cathedral Isle of Man
Ellan Vannin Pipes and Drums
Name of Piper: Pipe Major John Struthers

CHANNEL ISLANDS

Jersey

Town Church, St Helier
Jersey Pipe Band
Name of Piper: Pipe Sergeant David Reid

BELGIUM

Ypres

Ypres and Surrey Pipes and Drums

OTHER PIPERS TAKING PART THROUGHOUT THE WORLD

**The City of Norwich Pipe Band, Norwich,
Norfolk, England, were the first Band in
the world to confirm that all their their
pipers would be taking part in the playing
of 'Battle's O'er' at 6am on 11th
November 2018, at individual locations in
their area.**

Piper Robert Gunther - Location: Memorial
Square, USA Army Base, Wiesbaden,
GERMANY
Piper Alexandra Greenwood - Location: 3
Forge Road, Are, SCOTLAND
Piper Dennis Duncan - USA National
Cemetery, Marietta, Georgia, USA
Piper J Anderson - Location: Weedon Bec
Memorial, Northampton, ENGLAND
Piper Michael Bates - Saint Wilfred Church,
Pevensey Bay, East Sussex, ENGLAND

Piper Anne Lore - Location: War Memorial,
Place Du Commando, Saint-Nazaire, FRANCE
Piper Randall Stiles - Location: Church in
Texas, USA
Piper Adrian Vaughan - Location: Iowa, USA
Piper Brian Baldwin - Location: Des Moines,
USA
Piper Dawn Baldwin - Location: Des Moines,
USA
Piper Jim Dawson - Location: Woodside, of
Balhaldie, Braco, Dunblane, NORTHER
IRELAND
Piper Timothy J O Gatehouse: Location:
2809Broad Avenue, Altoona, USA
Piper Kevin Walker - Location: Cefn Cribwr
War Memorial, Cefn Cribwr, South Wales
Piper Anne Betty - Location: Blackburn
Cathedral, Blackburn, Lancashire, ENGLAND
Piper Douglas Watson - Location: TBC
Piper Lisa DeMerchant - Location: TBC
Piper Al Hunter - Location: Munloch War
Memorial, Inverness-shire, Highland,
SCOTLAND
Piper Bud Miller - Location: TBC
Piper Mark Jackson - Location: 1, Barnton
Place, Dumfries, SCOTLAND
Piper Fletcher Haley - Location: Poppy
Garden, London, ENGLAND
Piper Frank Anderson - London: Cenotaph,
Brantford, Ontario, CANADA
Piper Paul McGowan - Location: TBC
Piper Laurence Ching - Location: TBC, Texas,
USA
Piper Jennifer S R Hutcheon - Location: TBC
Piper Jeff Forrester - Location: Walmart,
Abingdon, Tennessee, USA
Piper Robbie Barrett - Location: TBC
Piper Richard Scott - Location: Craigclowan
School, Perth, Perth & Kinross, SCOTLAND

Piper Dan Kelley - Location: West Linn,
Oregon, USA
Piper John Atkinson-Millmoor - Location:
Stanhope, County Durham, ENGLAND
Piper Nick Reeves - Location: TBC
Piper Alexi Guretzke - Location: Castle
Ehrenbreitstein, Koblenz, GERMANY
Piper John Innes - Location: TBC
Piper Tim Fountain - Location: TBC
Piper David Brown - Location: In the bush of
Northern Ontario while hunting, Ontario,
CANADA
Piper Desmond Davidson: Location:
Aghadowey Parish Church, Aghadowey,
Coleraine, Northern Ireland
Piper Diron Cundiff - Location: TBC
Piper Jimmie Innes - Location: RNLI Lifeboat
Station, Lytham, Lancashire, ENGLAND
Piper Tommy Nimmo - Location: Abercorn
Church, South Queensferry, West Lothian,
SCOTLAND
Piper Sylvia McBeal - Location: The Memorial,
Station Road, Ashwell, Hertfordshire,
ENGLAND
Piper Martin McBeal - Location: The Memorial,
Station Road, Ashwell, Hertfordshire,
ENGLAND
Piper Renaud Olgiati - Location: TBC,
PARAGUAY
Piper Rob Bellew - Location: Salado Museum,
Main Street, Salado, Texas, USA
Piper Kathleen Little - Location: Glen Oaks
Cemetery, Oakville, Ontario, CANADA
Piper Andrew Head - Location: Perth,
AUSTRALIA
Piper John Cavanaugh - Location: Maple
Grove Cemetery, Lake, USA
Piper Emmanuel Corbasson - Location:
Battlefields of Somme, FRANCE



Acknowledgements

Piper Donna Myles - Location: 89, Lilybank Crescent, Forfar, Angus, SCOTLAND
Piper Michael Heaslip - Location: On a hill overlooking the sea, St Austell, Cornwall, ENGLAND
Piper Patrick Rafferty - Location: Flushing Cemetery, New York, USA
Piper Cheri Collett - Location: Canton, Georgia, USA
Piper Serge Ropars - Location: Jallans, Eure-et-Loir, FRANCE
Piper David Miller - Location: St Olaf's Cemetery, Kirkwall, Orkney Islands, ORKNEY
Piper Rhory More - Location: War Memorial, Teston Village, Kent, ENGLAND
Piper John English - Location: War Memorial, Van Neste Park, New Jersey, USA
Piper Robin Bartholomew - Location: Winchester Cathedral, Winchester, ENGLAND
Piper Robert L Roberts - Location: Long Island National Cemetery, Farmingdale, Atlantic Ocean, USA
Piper David Boling - Location: Huntsville Madison County Memorial, Madison, Alabama, USA
Piper Chris Earl - Location: TBC, AUSTRALIA
Piper Peter Quinn - Location: Rosetta Church, KwaZulu-Natal, SOUTH AFRICA
Piper Ray Murphy - Location: TBC, New Jersey, USA
Piper Peter McMahon - Location: 100-02 159 Avenue, Queens, New York, USA
Piper Matt van Klaveren - Location: Spijkenisse, NETHERLANDS
Piper Michael F Bell - Location: Veterans' Memorial, Galloway, New Jersey, USA
Piper Annie Faivre and Adore Bayart - Location: Fleurey-sur-Ouche, FRANCE
Piper Heather Shelswell - Location: Orillia, Brechin, Ontario, CANADA

Piper Bruce Stephen - Location: TBC
Piper Don Ormiston - Location: Victoria, AUSTRALIA
Piper Alexandra Calum Bell - Location: TBC
Piper Andrew Jack Bell - Location: TBC
Piper Bobby Allen - Location: The Cenotaph, Muirhead, Chryston, North Lanarkshire, SCOTLAND
Piper Roly Monague Jr - Location: TBC, Christian Island, Ontario, CANADA
Piper Nigel Bell - Location: Claygate, Quarry Brae, Harlow, Canonbie, Dumfries & Galloway, SCOTLAND
Piper Kevin Bunt - Location: TBC, Windsor, Ontario, CANADA
Piper James A McGowan - Location: Cape Town Cathedral, Cape Town, South Africa
Piper Robert Blackmore - Location: Liverpool Anglican Cathedral, Merseyside, ENGLAND
Piper Jeffrey A Williams - Location: The United States Special Operations Command, MacDill Air Force Base, Florida, USA
Piper John OBoyle - Location: The War Memorial, Broughton, Brigg, North Lincolnshire, ENGLAND
Piper Maclean Harry - Location: TBC
Piper Anthony Byrne - Location: TBC
Piper Chuck Penny - Location: TBC, Orillia, Ontario, CANADA
Piper Michelle Jewell - Location: Corby, Northamptonshire, ENGLAND
Piper Mick Murray - Location: Corby, Northamptonshire, ENGLAND
Piper Scott McNeil - Location: Tiny, Ontario, CANADA
Piper Paul Patterson - Location: Cenotaph, Orillia Soldiers Memorial Hospital, Ontario, CANADA
Piper Bob Salmon - Location: Wir Peerie House, Windmill Road, Bradfield, Essex, ENGLAND

Piper Mike Simmons - Location: 46 Hillside Gardens, Braintree, Essex, ENGLAND
Piper Albert McGalliard - Location: TBC, Jones County, Georgia, USA
Piper Andy Tasker - Location: Horsforth War Memorial, Horsforth, Leeds, Yorkshire, ENGLAND
Piper Brian Ross - Location: TBC
Piper Andrew Whitelaw - Location: Bristol, ENGLAND
Piper David Danks - Location: Leeds, Yorkshire, ENGLAND
Piper Dr Dan Hock OD - Location: Evergreen, Colorado, USA
Piper Sergeant John Sturgeon - Location: 8 Acacia Avenue, Robbinsville, New Jersey, USA
Piper Philip Duthie - Location: War Garden, Victoria Embankment, Nottingham, ENGLAND
Piper Birger Milling Eriksen - Location: Sct. Jacobi Church, Kirkepladsen, Varde, DENMARK
Piper Igor Obratzov - Location: War Memorial, Izmailovskiy Park, Moscow, RUSSIA
Piper James Felder - Location: Manhattan, New York City, USA
Piper Andrew Isaac - Location: 43 Echo Landing Road, Moultonborough, New Hampshire USA
Piper Dale Romagnoli - Location: Ganges Harbour, Salt Spring Island, British Columbia, CANADA
Piper Dave Law - Location: Sheerness, Kent, ENGLAND
Piper David Wilson - Location: Sheerness, Kent, ENGLAND
Piper Maurice Remillard - Location: 107 Amberjack Road, Groton, New London, USA
Piper Adrian Vaughan - Location: Bridgend War Memorial, Bridgend, WALES

Piper Roland Rousselle - Location: Monument for the Dead, Allee de Grande, Fontaine, La Bouexiere, FRANCE
Piper Eric Soriot - Location: Monument for the Dead, Allee de Grande, Fontaine, La Bouexiere, FRANCE
Piper Richard Allison - Location: Veterans Memorial, Baraboo, Wisconsin, USA
Piper Francois Bergez - Location: Amiens, Somme, FRANCE
Piper Vaughan Grandin - Location: 13348 Foxhole Drive, Fairfax, USA
Piper Sandy J Keith - Location: Perthshire, SCOTLAND
Piper Willie Nicol - Location: Comrie War Memorial, USA
Piper Andy Ballantyne - Location: 300 Las Vegas Blvd, Las Vegas, Clark, USA
Piper Gareth Waddell - Location: Perth, AUSTRALIA
Piper Paul Stevens - Location: Local Cenotaph, Luggershall, Southampton, Hampshire, ENGLAND
Piper James Carmichael - Location: Phillip Marx Central Park, Tehachapi, California, USA
Piper Mary Macpherson - Location: Cupar War Memorial, Fife, SCOTLAND
Piper Robert (bob) Ash - Location: War Memorial, Warlingham, Surrey, ENGLAND
Piper Russell Hurd - Location: TBC
Piper Michael Krogmann - Location: Texas, USA
Piper John Swanson - Location: 4395 Glidden Dr. Sturgeon Bay, Door County, USA
Piper Finlay Scott - Location: Craigclowan School, Edinburgh Road, Perth, Perth & Kinross, SCOTLAND
Piper Zoe Brumfield - Location: Forest Mississippi, USA



Acknowledgements

Piper Alexander Brodie - Location: Dundee Police War Memorial, Bell Street, Dundee, SCOTLAND
Piper Don Lewis - Location: Breage, Cornwall, ENGLAND
Piper Phil Puls - Location: TBC
Piper Paul Halkyard - Location: Tenerife, Canary Islands, SPAIN
Piper Victoria MacKenzie - Location: Photo Cathedral of St James, Vancouver, Washington, USA
Piper Kyle Dawson - Location: War Memorial, Maddison Square Park, New York City, USA
Piper Stuart Letford - Location: War Memorial, Birnam, Perth & Kinross, SCOTLAND
Piper Matthew J Tierney - Location: Delaware War Memorial, Delaware County Courthouse, Media, Pennsylvania, USA
Piper Robert Aggus - Location: Township of Puslinch Remembrance Service, Aberfoyle, Ontario, CANADA
Piper Derek Holdsworth - Location: TBC
Piper Tony Hill - Location: 2216, Brookside Drive, Tarrant, Tarrant County, Texas, USA
Piper Douglas Ratcliffe - Location: War Memorial, Bishop Auckland, Durham, ENGLAND
Piper James R Gillies - Location: Bonnyrigg, Midlothian, SCOTLAND
Piper Mark Schmidt - Location: TBC
Piper Reg Scott - Location: Coldstream, British Columbia, CANADA
Piper Stephen Cairney - Location: Duntocher, Clydebank, SCOTLAND
Piper Colin K Gavin - Location: Naperville, Illinois, USA
Piper John A (Jack) MacIsaac - Location: New Glasgow Park, Pictou County, Nova Scotia, CANADA
Piper Joseph Brady - Location: North Carolina, USA

Piper Frank McGoldrick - Location: Rugby, Warwickshire, ENGLAND
Piper Francis Whitehead - Location: Church Yard, Christ Church, Chester Road, Rossett, Wrexham, WALES
Piper Marcia Like - Location: 1443 E, Washington Blvd, Pasadena, California, USA
Piper Andrew Walley - Location: War Memorial, outside St Helen's Church, Etwell, Derbyshire, ENGLAND
Piper Keith Davey - Location: Drighlington War Cenotaph, Whitehall Road, Drighlington, Leeds, ENGLAND
Piper Ryan Fountain - Location: Oromocto War Memorial, Oromocto, New Brunswick, CANADA
Piper Uri Schleifer - Location: St Andrew's Scottish Church and Guesthouse, Jerusalem, ISRAEL
Piper Steve Jackson - Location: Heighington Village War Memorial, County Durham, ENGLAND
Piper Jamie Johnston - Location: St Albert, Alberta, CANADA
Piper Andrew Wallace - Location: Blanefield War Memorial, Blanefield, Stirlingshire, SCOTLAND
Piper Don McCammon - Location: County Courthouse Lawn, 200 West Broadway, Downtown Missoula, Montana, USA
Piper Donna McCammon - Location: County Courthouse Lawn, 200 West Broadway, Downtown Missoula, Montana, USA
Piper Graham Durant-Law - Location: Queanbeyan, New South Wales, AUSTRALIA
Piper Donald J McRae - Location: Gourrock Cenotaph, Greenock, Renfrewshire, SCOTLAND
Piper Alan Harrison - Location: Hereford Cathedral, Hereford, ENGLAND

Piper David Brown - Location: TBC
Piper Hardy Spoehr - Location: Honolulu Natatorium (WW1 War Memorial), Hawaii, USA
Piper Daniel Shane - Location: Memorial Park, Long Beach, Los Angeles, California, USA
Piper Margaret Macbrayne - Location: Argyll, SCOTLAND
Piper Yves Tripon - Location: Blain, Loire-Atlantique, Brittany, FRANCE
Piper Mark David Kauder - Location: 46, Redcote Close, Southampton, Hampshire, ENGLAND
Piper Brian A Simpson - Location: Stirling, SCOTLAND
Piper Scott Manson - Location: Ayr War Memorial, Ayrshire, SCOTLAND
Piper Hugh Ward - Location: Bothwell Cenotaph, Bothwell, South Lanarkshire, SCOTLAND
Piper Daniel Guichard - Location: Saint-Jacut de la Mer, Brittany, FRANCE
Piper Salmun Mousavi - Location: Leo Carillo State Beach, Malibu, USA
Piper Dietmar Fahrenwald - Location: National Memorial Place, "Neue Wache", Unter den Linden, Berlin, GERMANY
Piper David R Celebrezze - Location: Ohio, USA
Piper David Locky - Location: TBC
Piper Carol Jaquith - Location: Rochester, Minnesota, USA
Piper Robert Dickie - Location: 185 Mill Road, Lanarkshire, SCOTLAND
Piper Kinross Kebbell - Location: Peterborough Cathedral, Peterborough, Cambridgeshire, ENGLAND
Piper Robert Keys - Location: Cenotaph, Old Glasgow Road, Uddingston, South Lanarkshire, SCOTLAND
Piper Tony Gardiner - Location: Dayboro Cenotaph, Queensland, AUSTRALIA

Piper Gary Dickey - Location: Westlake Village, Ventura County, California, USA
Piper Eddie Selden - Location: War Veterans Memorial, Main Street, Seabrook, Texas, USA
Piper Petra Lage - Location: War Memorial, Sievern, Niedersachsen, GERMANY
Piper James Buchanan - Location: Rutland, ENGLAND
Piper Stewart Marshall - Location: Stirlingshire, SCOTLAND
Piper Tom Gray - Location: Derby, Derbyshire, ENGLAND
Piper Cassie Rowantree - Location: TBC
Piper Chris Davidson - Location: Church of Our Lady, Durley, Hampshire, ENGLAND
Piper Neil Whitehead - Location: War Memorial, Lower Hutt, NEW ZEALAND
Piper Peter Moore - Location: NSW, AUSTRALIA
Piper Joan MacLunny - Location: Naval Chapel, Naval Air Base, Pensacola, Florida, USA
Piper Alister Smith - Location: Cenotaph, Maclean, New South Wales, AUSTRALIA
Piper Alan Munro - Location: Retirement Village, Johannesburg, SOUTH AFRICA
Piper Robert Larcom - Location: Doral, Florida, USA
Piper David Pulled - Location: TBC
Piper Tony Best - Location: Hinchingsbrooke House, Huntingdon, Cambridgeshire, ENGLAND
Piper Ian A Reid - Location: 31st/42nd Battalion The Royal Queensland Regiment Soldiers Memorial, Passchendaele Lines, Lavarack Barracks, Townsville, Queensland, AUSTRALIA
Piper Russell White - Location: TBC
Piper Sandro Murru - Location: Mogadishu, SOMALIA



Acknowledgements

Piper Stephen Beattie - Location: TBC
Piper Jonathan Swan - Location: Tower of Chelmsford Cathedral, Chelmsford, ENGLAND
Piper David Burrous - Location: TBC
Piper Colin Dunlop - Location: TBC, NEW ZEALAND
Piper Iain Bell - Location: Canonbie War Memorial, Dumfries & Galloway, SCOTLAND
Piper Revd Des Plint - Location: Cenotaph, Oxford Street, East London, SOUTH AFRICA
Piper Doug Russell - Location: Florida, USA
Piper David Barrett - Location: Future Site of the WW1 War Memorial, Washington DC, USA
Piper Burns Curtis - Location: Oklahoma, USA
Piper Matt Evans - Location: Duncansville, Pennsylvania, USA
Piper James Reid - Location: Morpeth, Northumberland, ENGLAND
Piper Don Noakes - Location: Nanaimo, British Columbia, CANADA
Piper Dr Elaine Marshall - Location: TBC, Edinburgh, SCOTLAND
Piper Graeme Foster - Location: Wanganui, NEW ZEALAND
Piper Peter Lambert - Location: War Memorial, Littlemoor, Yorkshire, ENGLAND
Piper Christopher T Lancaster M.D. - Location: Winter Park, Florida, USA
Piper Adrian Jameson - Location: Kings Park War Memorial, Perth, AUSTRALIA
Piper Michael Pretsell - Location: Kings Park War Memorial, Dalkeith, Edinburgh, SCOTLAND
Piper Andy Grant - Location: Alnwick Memorial, Northumberland, ENGLAND
Piper John McCain - Location: Fort Worth, Texas, USA
Piper Richard Rush - Location: Loudon Park Cemetery, Baltimore, Maryland, USA

Piper Mick Barnard - Location: TBC, Isle of Wight, ENGLAND
Piper Alasdair Stuart - Location: Newtonmore War Memorial, Highland, SCOTLAND
Piper Kevin York - Location: Market Place, Bishop Auckland, County Durham, ENGLAND
Piper Ian Kinloch - Location: Dromore War Memorial, Dromore, County Down, NORTHERN IRELAND
Piper Ian Matthews - Location: Murcia, SPAIN
Piper Graeme Foster - Location: Whanganui, North Island, NEW ZEALAND
Piper Steven Bathory-Peeler - Location: Franklin, Massachusetts, USA
Piper John Dedullen - Location: Kapellen, Antwerp, BELGIUM
Piper David Harper - Location: Norwich, Norfolk, ENGLAND
Piper David Stark - Location: South Lanarkshire, SCOTLAND
Piper Menez Herve - Location: Saint-Nazaire, Brittany, FRANCE
Piper Peter Cound - Location: TBC
Piper Oliver Calman - Location: Sydney, AUSTRALIA
Piper John Young - Location: TBC
Piper Sean Slater - Location: Noddfa, Olmarch, Ceredigion, WALES
Piper David Harrington - Location: Wallace, USA
Piper Tom Wright - Location: Willoughby, Ohio, USA
Piper Jim Farley - Location: 62 Apollo Parade, Palmerston North 4414, NEW ZEALAND
Piper Ron Hitchcock - Location: Regina, Saskatchewan, CANADA
Piper Alister Smith - Location: Harwood, New South Wales, AUSTRALIA
Piper Roger Bayes - Location: Norwich, Norfolk, ENGLAND

Piper Jacob Millin - Location: Cromer, Norfolk, ENGLAND
Piper Andrew I MacKenzie - Location: Portsmouth, Hampshire, ENGLAND
Piper Paddy McGowan - Location: Birmingham, West Midlands, ENGLAND
Piper Pascal Reber - Location: Charleston, South Carolina, USA
Piper Rory Marsden - Location: Norfolk, ENGLAND
Piper Ian Miller - Location: Larne, County Antrim, NORTHERN IRELAND
Piper Don Lewis - Location: TBC
Piper Thomas McCulloch - Location: TBC
Piper Professor Steven D. Hays - Location: Polwarth Building, Aberdeen, SCOTLAND
Piper David Ian Weir - Location: Surbiton, Royal Borough of Kingston upon Thames, London, ENGLAND
Piper Sam Wright - Location: FRANCE
Piper Michael Bates - Location: East Sussex, ENGLAND
Piper James Innes - Location: 65 Broadwood Way, Lancaster, Lancashire, ENGLAND
Piper Halliday Mac - Location: TBC
Piper Adrian Eaton - Location: Surrey, ENGLAND
Piper Geoff Calvert - Location: Isle of Harris, SCOTLAND
Piper Neill Kemp - Location: 119 Raeberry Street, Glasgow, SCOTLAND
Piper Gilbert MacKay - Location: Okeham, 9 Glebe Lane, East Renfrewshire, SCOTLAND
Piper Andy Wright - Location: Albert, CANADA
Piper Don Wright - Location: AUSTRALIA
Piper William Reed - Location: Middlesex, Massachusetts, USA
Piper Paula Mary Howes - Location: Pudsey, Leeds, West Yorkshire, ENGLAND
Piper Michael Shanahan - Location: Royal Hospital, Chelsea, London, ENGLAND

Piper Michael Littlejohn, 1400 Linden Avenue, Carpinteria, California, USA
Piper Susan - Location: Norfolk, ENGLAND
Piper Euan Mackinnon - Location: Auchterarder, Perth & Kinross, SCOTLAND
Piper David Makin-Byrd - Location: Pennsylvania, USA
Piper Amanda Spangenberg - Location: Hershey, PA, Pennsylvania, USA
Piper Rab Letham - Location: 155 Godstone Road, Surrey, ENGLAND
Piper John Johnstone - Location: 57 Main Street, Stone, West Lothian, SCOTLAND
Piper Charles MacNeill - Location: 4 Blakelaw Road, Alnwick, Northumberland, ENGLAND
Piper Barry Flynn - Location: AUSTRALIA
Piper Michael McGee - Location: Arizona, USA
Piper Catriona Hill - Location: TBC
Piper Glenn Craig - Location: 32 Subline Point Avenue, Tascott, New South Wales, AUSTRALIA
Piper Douglas Glover - Location: 443 Victoria Street, Ontario, CANADA
Piper Terry Smith - Location: TBC
Piper Brian O'Neil - Location: Kaslo, British Columbia, CANADA
Piper Ross McNaughton. - Location: Army School of Piping, Edinburgh, SCOTLAND
Piper Gregor MacGregor - Location: 342 East Main Street, Gaylord, Michigan, USA
Piper Phillip Hopkins - Location: Victoria, British Columbia, CANADA
Piper Ruth Wright - Location: 1 Northbridge Park, St Helen Auckland, County Durham, ENGLAND
Piper Rod Caird - Location: Ipswich, Suffolk, ENGLAND
Piper David Winkler - Location: TBC



Acknowledgements

Piper Duncan Brown - Location: The Lanarkshire Victoria Cross Memorial, Hamilton, Lanarkshire, SCOTLAND (Duncan Brown was responsible for the erection of the monument in Hamilton Town Square, and is dedicated to the 14 men from the County of Lanarkshire who were awarded the Victoria Cross).

Piper Max Lloyd - Location: Bury St Edmunds, Suffolk, ENGLAND

Piper Jane MacRae - Location: Hoveton, ENGLAND

Piper Denise Ramsbottom - Location: Norwich Railway Station, Norwich, Norfolk, ENGLAND

Drummer Val Fryer - Location: Norwich Railway Station, Norwich, Norfolk, ENGLAND

Piper Steve Law - Location: Norwich Railway Station, Norwich, Norfolk, ENGLAND

Piper Tom Foster - Location: Band Stand, Pavillion Gardens, Gorleston-on-Sea, Great Yarmouth, Norfolk, ENGLAND

Piper Ian Soulsby - Location: Martham War Memorial, St Mary's Church, Martham, Norfolk, ENGLAND

Piper Ian Robertson - Location: War Memorial, Tacolneston (South Norfolk) Church, Norfolk, ENGLAND

Piper Michael Ovenden - Location: Ness Point, Lowestoft, Suffolk ENGLAND



TMS Media - Pagemasters to the Pageantmaster



24-page brochure for Trafalgar Weekend
21-23 October 2005.



8-page menu for Trafalgar Night Dinner
21 October 2005.



8-page guide to taking part in The Great Poppy Party Weekend
10, 11, 12 June 2011.



8-page guide to taking part for The Queen's Diamond Jubilee Beacons
4 June 2012.

Few design agencies have the privilege of working on projects of national significance.

From celebrations to mark the 200th anniversary of the Battle of Trafalgar and the 90th anniversary of the Royal British Legion to Fly a Flag for the Commonwealth, TMS Media has had the pleasure of working with Pageantmaster Bruno Peek on events that celebrate many important milestones in our history and culture.

Much of Bruno's work has associations with historic anniversaries, for example, The Queen's Diamond Jubilee Beacons project was a high-profile televised celebration for which we designed a guide to taking part and a website for people and organisations to register events around the country.

Our creative work for the hugely successful Fly a Flag for the Commonwealth in 2013 also included a website and a guide, which has been updated to showcase some of the many exciting events that took place in its inaugural year.

We're delighted to be the Pagemasters to the Pageantmaster.

01493 662929 www.tms-media.co.uk



8-page guide to taking part for 70th Anniversary of VE Day 8 May 2015



8-page guide to taking part for Fly the Red Ensign for Merchant Navy Day
3 September 2015



A unique 124-page leather-bound book listing all the Beacon locations for The Queen's Diamond Jubilee Beacons was presented to The Queen 4 June 2012.



36-page guide to taking part for Fly a Flag for the Commonwealth
14 March 2016



20-page guide to taking part for The Queen's 90th Birthday Beacons
21 April 2016



BATTLE'S OVER



A NATION'S TRIBUTE

11TH NOVEMBER 2018

100 YEARS OF REMEMBRANCE

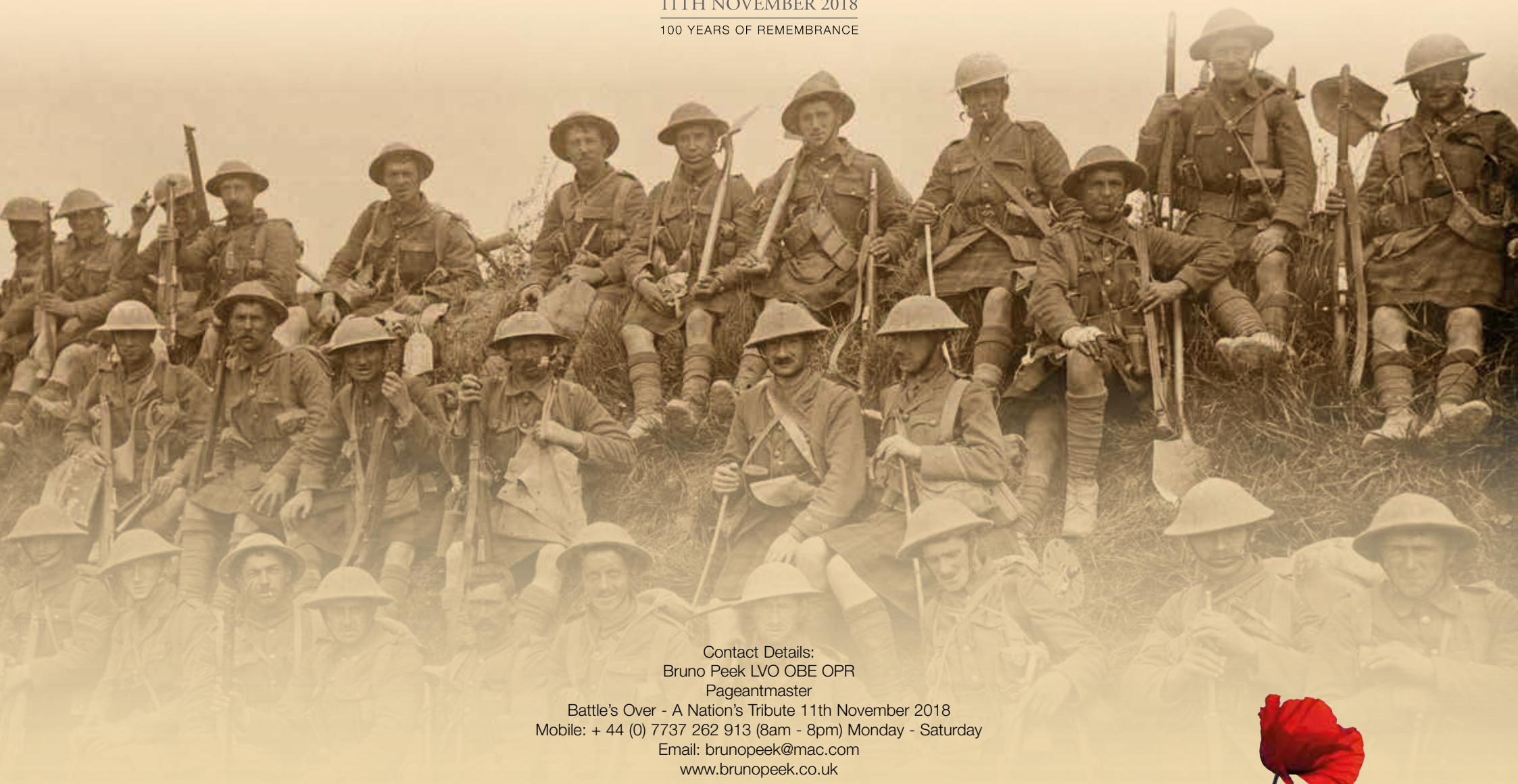

Contact Details:

Bruno Peek LVO OBE OPR

Pageantmaster

Battle's Over - A Nation's Tribute 11th November 2018

Mobile: + 44 (0) 7737 262 913 (8am - 8pm) Monday - Saturday

Email: brunopeek@mac.com

www.brunopeek.co.uk

