



THE QUEEN'S
PLATINUM JUBILEE
BEACONS
2ND JUNE 2022



YOUR GUIDE TO TAKING PART



Certificate of Grateful Recognition



This A4 certificate will be sent to all participants at the end of June 2022, via email, enabling them to print, frame and keep it as a permanent reminder of the moment in history celebrated.

You may wish to print off extra copies, presenting them to those assisting you in this special tribute to Her Majesty The Queen.

Introduction

A warm welcome to all our fellow celebrators.

There is a long and unbroken tradition in our country of celebrating Royal Jubilees, Weddings and Coronations with the lighting of beacons - on top of mountains, church and cathedral towers, castle battlements, on town and village greens, country estates, parks and farms, along beaches and on cliff tops. In 1897, beacons were lit to celebrate Queen Victoria's Diamond Jubilee. In 1977, 2002 and 2012, beacons commemorated the Silver, Golden and Diamond Jubilees of The Queen, and in 2016 Her Majesty's 90th birthday.



The Queen's Diamond Jubilee Beacon, The Mall, London, 4th June 2012.
©Press Association Images.



Town Crier, James Donald - Howick, New Zealand.

On 2nd June 2022, we will celebrate another unique milestone in our history, Her Majesty The Queen's 70th year as our Monarch and Head of the Commonwealth - her Platinum Jubilee. It is a feat no previous monarch has achieved.

More than 1,500 beacons will be lit throughout the United Kingdom, Channel Islands, Isle of Man and UK Overseas Territories, and one in each of the capital cities of Commonwealth countries in recognition of The Queen's long and selfless service. The beacons will enable local communities, individuals and organisations to pay tribute to her as part of the official Platinum Jubilee Weekend of celebrations from 2nd to 5th June 2022.

There are three types of beacons being lit for this historic occasion:

- A free - standing beacon fuelled by bottle gas (see pages 16 & 17)

- A beacon brazier with a metal shield. This could be built by local craftsmen/women or adopted as a project by a school or college (see page 18).

- A bonfire beacon and (see page 19)

Communities with existing beacon braziers are encouraged to light these on the night.

If you wish to take part, you can register your participation by providing the information requested on **page 15** under the heading, "How to take part," sending it direct to brunopeek@mac.com.



Bonfire Beacon (HM The Queen's Diamond Jubilee, 4th June 2012). Inveraray Castle, Scotland.
© Inveraray Castle.



A gas fuelled beacon on HM Tower of London in celebration of The Queen's Diamond Jubilee. Photo provided by courtesy of HM Tower of London.

Town Criers

At **2pm** local time Town Criers are being invited to undertake the Proclamation (see page 9) announcing the lighting of the beacons later that evening. **Pipers - at 9.35pm** local time across the UK and the Commonwealth, individual pipers and pipe bands are being asked to play "Diu Regnare" from central locations of their choice from within their local communities as their personal tribute to Her Majesty The Queen. (This time will vary in each time zone across the world). This unique tune has been especially written for this historic Jubilee by Piper Stuart Liddell, 2020 Glenfiddich

Champion and Pipe Major of the World Champion Pipe Band, Inveraray and District (**see page 11**).

To officially announce the lighting of the beacons at **9.45pm** local time in the country they are in, we have had a unique Bugle Call written, entitled 'Majesty,' and would like to encourage Buglers and Cornet players to undertake this at **9.40pm** on the night from the individual beacon locations within local communities, adding another colourful element to this special tribute to Her Majesty the Queen by musicians from within local communities – (**see page 12**).



Piper Robert Cunningham on the Peak of Scafell Pike, England. By kind permission of The National Trust.

"The Royal Scottish Pipers' Society are honoured to participate in our Patron The Queen's Platinum Jubilee Celebrations in June 2022.

Her Majesty's extraordinary service to this country is unparalleled. Accordingly, we encourage everyone to express their appreciation and gratitude by supporting this amazing Jubilee event," said Gordon Wallace, Hon. Pipe Major, Royal Scottish Pipers' Society.

Alan Hay, Chairman of The Royal Celtic Society whose Patron is Her Royal Highness The Princess Royal said, "Having for two hundred years been at the cutting edge of traditional music and language in Scotland, we recognise the enormous commitment Her Majesty The Queen, has made in serving the Commonwealth and its people. We are delighted therefore, to encourage all our members to participate in the Jubilee celebrations and our pipers to play Diu Regnare, composed by our member Stuart Liddell in honour of this historic event."

The National Piping Centre, whose Patron is His Royal Highness The Prince of Wales, is also delighted to be involved in The Queen's Platinum Jubilee Beacons, and will be encouraging



Northumbrian Piper Andrew Davidson.

pipers throughout the UK, Channel Islands, Isle of Man, and in the capital cities of the Commonwealth, to play this special tune five minutes before the beacons are lit that evening.

“The Royal Scottish Pipe Band Association would be delighted to support such an auspicious occasion and we will invite all our members to support this initiative as events like these help promote the long standing relationship the The Royal Scottish Pipe Band Association has with The Royal Family and we congratulate Her Majesty The Queen on her Platinum Jubilee,” said Kevin Reilly, Chairman RSPBA.

“The Northumbrian piping community will be extremely thrilled and honoured to be involved in this tremendous project being organised to recognise The Queen’s Platinum Jubilee,” said Tom Fairfax - Trustee, Northumbrian Pipers’ Society.

A Song for the Commonwealth

To coincide with the lighting of the Beacons, choirs of all types and sizes within local communities are warmly encouraged to sing this unique ‘Song for the Commonwealth,’ the winner of a Commonwealth-wide song competition organised over the last few months, filling the world with the sound of music and song in celebration of this special moment in The Queen’s life. The song should be sung at exactly **9.45pm** local time in whichever country they are in, on 2nd June 2022. Please sign up your choir for what promises to be a wonderful opportunity, using this link: <https://www.commonwealthresounds.com/qjib/>

Important: Choirs taking part do not necessarily have to be linked to the lighting of a beacon, it is the involvement of your choir representing your local community in this special aspect of The Queen's Platinum Jubilee Beacons, from a location of your choice that evening, that is the most important - “voices around the globe joining together in celebration.”



“On behalf of the Military Wives Choirs, I am thrilled that we are to be a part of The Queen’s Platinum Jubilee Beacons. Our network brings together over 70

choirs united through the power of singing, and we are looking forward to sharing in this momentous celebration. We are eagerly anticipating the specially written song for the Commonwealth and look forward to our network rehearsing across the UK and internationally. It is only appropriate that this unique milestone in history is marked with music, the strength of which is evident. Our passion for singing is clear and we are honoured to make these performances into a special event for Her Majesty The Queen’s 70th year as our Monarch and Head of the Commonwealth on her Platinum Jubilee,” said Melanie Nightingale, Director, Military Wives Choirs.

Hadrian’s Wall runs from Wallsend in Tyneside through the county of Northumberland to the west of Carlisle, Cumbria, England. Photo by courtesy of Roger Clegg.





'I warmly encourage Christians and church choirs throughout the country to join in singing the 'Song for the Commonwealth' at 9.45pm on 2nd June 2022, as the Queen's Jubilee Beacons are lit throughout the United Kingdom, Channel Islands, Isle of Man and in each of the Capital Cities of the Commonwealth.

This will be a moment of remarkable celebration, as we join together across different generations, denominations, faiths and communities all over the world in proper tribute to Her Majesty the Queen. My prayer is that this might be a chance to truly celebrate Her Majesty's historic 70 years of service to her country and the Commonwealth, reaching out in friendship, and building community as we are reminded of our common bond under the Crown. May God watch over Her Majesty, may He bless her and her people, and may this wonderful celebration be an occasion to give thanks, both for the Queen and for the God of service and unity,' said *The Most Revd Justin Welby, Archbishop of Canterbury.*



Beacon Brazier, St Mary's Green, City of Ely, Cambridgeshire.

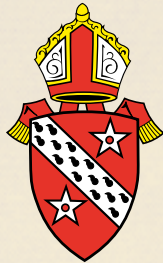

"The Church in Wales is delighted to be joining the tributes to her Majesty the Queen on the historic occasion of her platinum jubilee. We encourage church choirs of all faiths across Wales to join in singing the 'Song for the Commonwealth' at 9:45pm on the 2nd June 2022 as the jubilee beacons are lit across the United Kingdom and the capital cities of the Commonwealth. This is a

marvellous opportunity for disparate nations, communities, faiths and generations to join together in common fellowship and thank Her Majesty for the 70 years of service and leadership she has given to millions across the world. Let us lift our voices as one to honour both our Queen and the God she has served with such faith and diligence," said *The Right Reverend Andy John, Bishop of Bangor (Senior Bishop of the Church in Wales).*



"On behalf of the Church of Scotland, I am delighted to welcome this opportunity to celebrate Her Majesty The Queen's remarkable reign, and the example of faithful service which she has given during the last 70 years. We will be encouraging our congregations across Scotland and beyond to take part in singing the 'Song For the Commonwealth' at 9.45pm on the 2 June next year, at the same time that the jubilee beacons are lit in Britain and throughout the Commonwealth. We also give thanks to God for her witness and for the faithfulness with which she has served the nation. We look forward to joining others throughout the world at a time when coming together as a community has never felt more important." *Lord Wallace, Moderator of the General Assembly of the Church of Scotland.*



"Churches Together in England encourages church choirs throughout England, from every tradition, to come together in local communities, joining where possible with other community choirs at 9.45pm on 2nd June 2022, to make



Battel Bonfire Boyes. Photograph by Clifton Brothers.

the celebrations of Her Majesty the Queen's Platinum Jubilee truly memorable, and a fitting tribute to the dedication of her Majesty to the service of the nations of the United Kingdom and Commonwealth. This is an opportunity to join together ecumenically, and with the wider community, to make music, and build community. I hope that every choir in the land will find ways of embracing such a unique opportunity to make music together by singing the "Song for the Commonwealth," forming new friendships and deepening existing ones, in honour her Majesty and the God whom she serves with such faithfulness." *Rev'd Dr Paul Goodliff, General Secretary, Churches Together in England.*



IN BRITAIN AND IRELAND

"Churches Together in Britain and Ireland is delighted to support this initiative that encourages choirs across Great Britain and Northern Ireland to join together on the 2nd June 2022 as part of the celebrations of Her Majesty the Queen's Platinum Jubilee to sing together the "Song of the Commonwealth". We hope many choirs will take part and we give thanks for the service that Her Majesty has given over many decades and continues to give." *Dr Nicola Brady, General Secretary, Churches Together in Britain and Ireland.*

"Battel Bonfire Boyes, (photo above) the world's **oldest** bonfire society, is delighted to be lighting a beacon in celebration of The Queen's Platinum Jubilee as part of this amazing tribute," said Matt Southam, press and publicity officer.



"Help for Heroes is honoured to salute Her Majesty The Queen, as we did in 2012, by taking part in The Queen's Platinum Jubilee Beacons. Wounded veterans and their families will proudly

light beacons at the four furthest corners of the UK and the Help for Heroes choir will join with voices across the Commonwealth," said, *Melanie Waters, Chief Executive, Help for Heroes.*



"Fram Farmers and its members throughout Great Britain are delighted and honoured to be participating in Her Majesty The Queen's Platinum Jubilee on 2nd

June 2022. Farms and country estates will be lighting beacons in tribute to Her Majesty the Queen, continuing a long and unbroken tradition of celebrating Royal Jubilees, Weddings and Coronations. This will be the last chain of Beacons lit during The Queen's reign, a unique occasion for us all to join the nation's tribute to her Majesty, and we would encourage all Farms and Estates to be part of this historic occasion." *Andrew Knowles, Chief Executive Officer.*



The Queen's Platinum Jubilee Beacon Tart.

To celebrate this historic moment in The Queen's reign, we wanted to produce a special Tart made from produce from each of the four countries of the United Kingdom, that could be served either hot or cold at the individual Beacon locations, as well as those singing the Song for the Commonwealth from locations of their choice from within their local communities whether they were involved with a Beacon or not, so my friends from Country Women Country Wide have kindly devised a unique recipe for this Tart (see page 20), it's delicious.

"The RNLI are also thrilled to commit to the event by lighting a Beacon in each of their 6 lifesaving regions of the UK," said *Emily Foster, Bicentenary Campaign Manager RNLI.*



"The Royal Institution of Chartered Surveyors (RICS) is honoured to lead the lighting of the UK's Anchor Chain of beacons for our Patron's historic Platinum Jubilee. It is only fitting that this aspect of the beacons will be led by RICS Matrics, a key part of our organisation which supports many thousands of young professionals in shaping their own future history and lasting legacy." *Sean Tompkins, CEO RICS.*



"The NFU is delighted to be supporting The Queen's Platinum Jubilee Beacons and will be encouraging our members throughout England and Wales to light beacons as part of the celebration. From the uplands to the lowlands, our farmers will be lighting beacons on the most iconic parts of the countryside in tribute." *Minette Batters, President, NFU.*

Walking with the Wounded, one of our country's leading Forces charities, will light gas-fuelled beacons on top of the four highest peaks in the UK - Ben Nevis, Scotland; Scafell Pike, England; Mount Snowdon, Wales, and Slieve Donard, Northern Ireland, paying tribute to The Queen while raising valuable funds for the welfare of wounded service personnel.

Beacons will also be lit on The Queen's Sandringham and Balmoral Estates, at the Copper Horse statue of King George III in Windsor Great Park, Hillsborough Castle, Northern Ireland, and on the battlements of the Tower of London. In my home town of Great Yarmouth, Norfolk, the Borough Council will light its beacon brazier on the town's famous Golden Mile. One will also be lit outside the 17th century Tan Hill Inn in the Yorkshire Dales, the highest pub in Great Britain. English Heritage will light at least 17 beacons on heritage sites, and others will be lit in Enniskillen, County Fermanagh, Northern Ireland; Sark and Alderney in Channel Islands, St Davids, the most westerly City in Wales, and the Isle of Wight.

One Voice Wales, which has taken part in previous jubilee events, will be inviting member councils to light beacons, and Historic Houses will encourage member estates to participate too.



National Trust

"The National Trust is delighted to be playing an active role in The Queen's Platinum Jubilee Beacon lighting on 2nd June 2022, in celebration of this unique moment in The Queen's reign. We also took part in The Queen's Diamond and Golden Jubilee Beacons in June 2012 and 2002, as well as the First World War Centenary Beacon lighting in 2018 and look forward to welcoming visitors to attend this special tribute to Her Majesty The Queen," said *Justin Albert, Regional Director for Wales.*

In a similar way to previous Royal Jubilees, the Army Cadet Force Association will be actively supporting this special occasion by lighting the National Sports Beacon at the start of the National Athletics Championships in Grantham, England, one of many others across the UK.

Dyfed & Glamorgan Army Cadet Force will light a beacon on top of Pen-y-Fan, the highest peak in South Wales, as part of a pan-Wales Army Cadets event to mark the Jubilee.



We are also pleased to confirm the involvement of Girlguiding throughout the UK, Channel Islands and the Isle of Man, with *Girlguiding Chief Guide Amander Medler* saying,

"I'm delighted that Girlguiding is supporting the lighting of Beacons to celebrate this very special Jubilee marking the 70-year reign of our Patron Her Majesty the Queen."

Beacons are being lit on some of our country's oldest estates, including Woburn Abbey, Highclere Castle, Cholmondeley Castle, Hatfield House, Belvoir Castle, Holkham Hall, Houghton Hall, Bolton Abbey, Blenheim Palace, Arundel Castle, Chatsworth, Wellington, Roxburgh and Badminton. Hadrian's Wall Partnership and its communities along the Wall are also involved and will be lighting celebration beacons.

The Right Honourable Lord McLoughlin CH, BTA Chairman said, "I would like to encourage every City, County, Borough, District, Regional, Community, Town and Parish Council throughout Great Britain to light a beacon in celebration of this unique moment in The Queen's life, and would ask all those taking part to go to **page 15** of this Guide and register their involvement as soon as possible."

*Chiddingfold Bonfire Society Torchlight Procession.
Photograph by Steve Baker.*



Beacons will also be lit at Coastwatch Scotland's Irvine and St Monans stations by their groups of volunteers.

"The National Coastwatch Institution is delighted to be part of this important tribute to Her Majesty The Queen, and will be encouraging all its 56 watch stations around the coast of England and Wales to take part in lighting beacons on the night," said Commander Lesley Suddes RN, Chairman NCI.

"The Chiddingfold Bonfire Association (*photo below*) consider it a great honour in using this opportunity to pay tribute to Her Majesty The Queen by lighting a beacon in celebration of her Platinum Jubilee on behalf of our wonderful village and community. Our tradition of lighting beacons for Her Majesty The Queen extends all the way back to her Coronation in 1953, Silver, Golden and Diamond Jubilees and her 90th Birthday Beacons. The earliest known record of a beacon lighting in the village is for George V's Silver Jubilee of 1935," said Simon Manuel, Chairman of the Association.





TRINITY HOUSE

Captain Ian McNaught, Deputy Master of Trinity House, said, "I am pleased that we, at Trinity House, can support this event marking HM The Queen's Platinum Jubilee. By lighting beacons at lighthouses around our shores we will help make this a celebration to remember and also honour our long-standing involvement with Her Majesty and The Royal Family."

Rotary



Great Britain & Ireland

"Rotary International Great Britain & Ireland are delighted to once again take part in Her Majesty's Platinum Jubilee Beacon Event as we were for the Diamond Jubilee, we look forward to clubs around Scotland, England, Ireland, Wales, The Channel Islands and the Isle of Man taking an active role in this prestigious event," said David Ellis, Chairman of the Executive, Rotary International Great Britain & Ireland.

nalc

National Association of Local Councils

Councillor Sue Baxter, NALC chair, said: "The National Association of Local Councils (NALC) is delighted to be supporting The Queen's Platinum Jubilee Beacons, and will be encouraging local councils throughout England to light beacons as part of this celebration".



QUEEN'S COMMONWEALTH TRUST
PLATINUM JUBILEE 2022

"The Queen's Commonwealth Trust (QCT), which was launched in recognition of Her Majesty The Queen's lifetime of service to others and her love for the Commonwealth and its young people, is delighted to be involved in The Queen's Platinum Jubilee Beacons' project, with QCT young leaders lighting beacons across the 54 Commonwealth countries in recognition of Her Majesty The Queen's 70 years of service and her belief that young people across the

Commonwealth are beacons of hope for our collective future," said Christopher Kelly, Chief Executive, The Queen's Commonwealth Trust.

As this will be the last chain of Beacons lit during The Queen's 70-year reign, we hope that individuals, local authorities, voluntary and youth groups, farming communities and others will join with the many organisations who have already agreed to take part in this special tribute to Her Majesty on 2nd June 2022. Let's make it the largest celebration of its kind the world has ever seen.

IMPORTANT: To enable us to register your involvement in this unique tribute to Her Majesty the Queen on 2nd June 2022, please go to **page 15** of the Guide and provide the information requested in **Step 1**, sending it directly to brunopeek@mac.com asap, or by **no later than 30th May 2022**, allowing us to send you updated information in due course.

To assist in the sustainability of our planet, we would like to encourage those lighting Beacons to plant a circle of seven trees, with each tree representing a decade in The Queen's reign.

IN ADDITION: If you would like your beacon lighting event to feature on the interactive map on the government's Platinum Jubilee website, please also submit details at: www.platinumjubilee.gov.uk/event-submission

Bruno Peek

Bruno Peek LVO OBE OPR
Pageantmaster
The Queen's Platinum Jubilee Beacons



A Proclamation



Oyez Oyez Oyez

*Today in our nation - and throughout the Commonwealth -
we are celebrating our glorious Queen's Platinum Jubilee.*

*Elizabeth - the second of that name -
our most beloved Sovereign and Head of the Commonwealth for seventy years.*

*How apt that this should be the Platinum anniversary of her accession -
Platinum - that most noble of metals,
more precious even than gold.*

*And so it is in honour of this unique occasion
that beacons will be lit this evening
throughout the United Kingdom,
the Channel Islands, the Isle of Man and the UK Overseas Territories -
and in all the Capital Cities of the Commonwealth.*

*Let it be known,
in proclaiming this tribute to Her Majesty the Queen on her Platinum Jubilee,
that we are one nation and one Commonwealth.*

God Save The Queen



Jane L. Smith, Bognor Regis Town Crier
and author of the Proclamation.



Diu Regnare

Music written by Pipe Major Stuart Liddell - Glenfiddich Champion Piper

The musical score for 'Diu Regnare' is presented in ten staves of music. The key signature is one sharp (F#) and the time signature is 6/8. The score includes various musical notations such as treble clefs, notes, rests, and repeat signs. There are first and second endings marked with '1' and '2' respectively. The music is written in a single melodic line.



Stuart Liddell at Duntrune Castle on the north side of Loch Crinan in Argyll, Scotland.

A handwritten signature of Stuart Liddell in black ink.

Majesty

The playing of Majesty at 9.40pm to fanfare the lighting of the Beacons at 9.45pm

What an honour to be asked to pen a bugle call to fanfare the lighting of The Queen's Platinum Jubilee Beacons.

To think that it will be sounded right across the world, to mark this truly historic event makes me very proud indeed.

It can be played by a solo bugler/cornet/trumpet or at the end of the call there is an opportunity to join with friends to fill the last chord with harmonies.

Buglers of all ages and all abilities should not find it a difficult piece.

So, play it as the title suggests, with Majesty.

*Bugler Sgt A.W. Carlisle
Hillsborough Fort Guard
Northern Ireland*

Allegretto

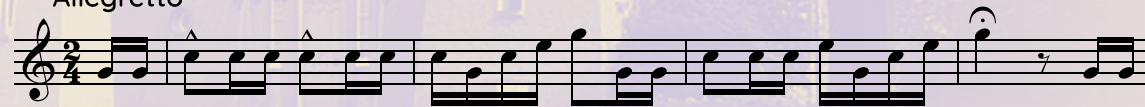

5



Rall.

Allargando

2021 Copyright A.W. Carlisle



A Song for The Commonwealth

A Life Lived with Grace



The competition was launched Commonwealth-wide on June 2nd 2021. We were delighted to receive so many excellent, meaningful entries from lyricists and composers throughout the Commonwealth. Every single piece of work has been carefully read or listened to before choosing the winner.

Sincere thanks also to H.E. Baroness Scotland Q.C, Secretary-General of the Commonwealth, Judith Weir CBE, Master of the Queen's Music, Bruno Peek LVO OBE OPR, Pageantmaster of The Queen's Platinum Jubilee Beacons who came up with the concept for The Song for the Commonwealth linked to the lighting of the Beacons on 2nd June 2022, Roderick Williams OBE, Baritone, Graham Trew MVO, Dr Anne Gallagher AO, Director-General of the Commonwealth Foundation and Stephen Miles GRSM FGMS who adjudicated the different stages of the competition with such skill and care.

The competition has been organised by Commonwealth Resounds under the excellent and dedicated leadership of Alison Cox OBE, Founder and Chairman of this organisation - www.commonwealthresounds.com.

The overall winners are Atueyi Vincent Chinemelu (composer) from Nigeria and Lucy Kiely (lyricist) from Australia.

The song is called 'A Life Lived with Grace'

It will be available via the link below from January 2nd 2022 for all choirs to download and learn <https://www.commonwealthresounds.com/qjpb/> Choirs - please use this link to SIGN UP AND REGISTER to take part in this exciting event!

WINNER Atueyi Vincent Chinemelu - Nigeria

BIOGRAPHY

Atueyi is a 38-year-old academic musician from Anambra State in Nigeria. He is a multi-instrumentalist who plays the piano, flute, cello, trumpet, alto-sax and guitar and in 2021 he received the Department Award of Excellence from the University of Uyo, Nigeria after studying there for 5 years. Ordained as a Roman Catholic Priest in 2011 after his Theological studies, Atueyi is credited with over a hundred religious, art and secular vocal music compositions, 30 piano works, arranged and composed orchestral pieces and musical solos. Presently, he has returned to the St. Dominic Savio Seminary in Akpu, Nigeria as Music Director again whilst preparing to further his studies in music to Master and Doctorate levels.



STATEMENT

"My joy rests on the fact that my humble effort has led to a gigantically bountiful harvest. I am so glad that my little song has attained a universal relevance and will cement the love and bond shared by all the peoples of the world as the song is sung as the Beacons are lit throughout the UK and the Commonwealth in celebration of The Queen's Platinum Jubilee on 2nd June 2022. I am happy that through our song, with the lyrics written by my friend Lucy Kiely, the love, peace and harmony promoted by the Commonwealth of Nations through their involvement in The Queen's Platinum Jubilee Beacons will become indelible in our minds and more real in our lives."

WINNER Lucy Kiely - Australia

BIOGRAPHY

Lucy Kiely is a 30-year-old singer songwriter from Sydney, Australia with a passion for jazz. After graduating from the University of Sydney, Lucy wrote, recorded and independently released two EPs and one LP of all original material inspired by her travels and life experiences. Lucy's releases have enjoyed worldwide exposure across a variety of platforms. These days Lucy performs regularly as a vocalist, is writing her second full-length album and is currently a semi-finalist across nine different categories in the 2021 UK Songwriting Contest.



STATEMENT

"To be selected as the winning lyricist on the unique occasion of The Queen's Platinum Jubilee is a once-in-a-lifetime honour and I extend my heartfelt congratulations to the winning composer. I am thrilled that my lyrics 'A Life Lived With Grace' will be performed by choirs and community singers as the Beacons are lit throughout the United Kingdom and the Commonwealth on 2nd June 2022, in celebration of Her Majesty The Queen's extraordinary 70-year reign."



A Song for The Commonwealth

A Life Lived with Grace



Many thanks to all the talented writers and composers from around the Commonwealth who submitted lyrics and music for The Queen's Platinum Jubilee Beacons Song for the Commonwealth Competition. We had an amazing response and received a large number of wonderful, heartfelt entries.

Bruno Peek LVO OBE OPR – Pageantmaster, The Queen's Platinum Jubilee Beacons

Alison Cox OBE – Founder and Chair of Trustees – The Commonwealth Resounds

Special congratulations to the following people:

Writers

Adya Rai (India), Alan Morris (UK), Amelia Moore (UK), Anjani George (India), Ann-Marie Inman (UK), Anne Jamieson (UK), Bernard Trafford (UK), Cameron Ingram (UK), Christopher Nocton (UK), Colin B Leonard (UK), David Morris (UK), David Vickers (UK), Dennis Raymond Higgins (UK), Evangeline Amoura (UK), Francis Rawlinson (UK), Henry James (Harry) Bowden (UK), Iwona Januszajtis (UK), James Peter Morris (UK), Janiel Kaez (Namibia), John Baker (UK), John Schofield (UK), Karen Litchfield (UK), Kathy Macrae (UK), Katie Spires (UK), Linda Petruzzella (UK), Lindsay Jupp (UK), Lucy Kiely (Australia), M.Khurram Hammad Khiraam Siddiqui (Pakistan), Mariam Saeed Khan (Pakistan), Marie Haswell (UK), Meenakshi Gautam Chaturvedi (India), Michael Baldwin (UK), Nektarios Diamantis (Cyprus), Nemo James (UK), Nicola Martin (UK), Robert Cranmer Bentley (UK), Rodrica Rudge (UK), Sandra Robinson (UK), Sherwood Grange Care Home Residents (UK), Simon Gadd (UK), Sonia Dixon (UK), Terry Sorfleet (UK), Thomas Newman (UK), Trevor Johnson (UK), Wanda Daszynska (UK).

Composers

Adriel Sukumar (Australia), Alec Thurbin (UK), Aliyah Ramatally (Trinidad and Tobago), Andrew Dharma (Australia), Ashley Powell (UK), Atueyi Vincent Chinemelu (Nigeria), Aurelia Walker (UK), Benji Lock (UK), Carl Simpson (UK), Carol Corns (UK), Chris Barrow (UK), Cole Lam (UK), David Hopper (UK), David Vickers (UK), Daxter Yeo (Australia), Edewede Oriwoh (Nigeria), Emmanuel Ansaeku (Ghana), Ethelbert Twumasi (Ghana), Frances Yonge (UK), Fraser Broadfoot (UK), Grahame Maclean (UK), Harry Baines (UK), Helen Furnell (UK), Innocent Okechukwu (Nigeria), John Farmer (UK), Jordan Rogers (New Zealand), Jude Mark Kaganda (Uganda), Kate Sloan (UK), Kenneth Done (UK), Khadijah Simon (Antigua and Barbuda), Lea Nixon (UK), Loretta Kay Feld (UK), Luka Disho (Botswana), Mark Waters (UK), Micheal Bakare (Nigeria), Nathanael Koh (Singapore), Patrice Ewoungouo (Cameroon), Patrick Davison (UK), Paul Whitfield (UK), Pete Duval (UK), Peter Foggitt (UK), Peter Rae (UK), River Hopkins (UK), Rob Lloyd (UK), Robert E Sprague (UK), Robert Walsh (UK), Rodrica Rudge (UK), Roger Peatman (UK), Samuel Yawson (Ghana), Santosh Ebenezer Baynes (India), Stella Fullard (UK), Stephen Joseph (UK), Stephen Olusoji (Nigeria), Steven Weyman (UK).

On January 2nd 2022 at 12 noon UK GMT, the names of composers from around the world who reached the shortlist and the final will be published by The Commonwealth Resounds on their website:

www.commonwealthresounds.com

Calling all choirs in cathedrals, churches, schools and also community singers in the UK and around the world.

This is your opportunity to play a unique role in history by signing up to sing

A SONG FOR THE COMMONWEALTH

'A Life Lived with Grace'

Music by Vincent Atueyi Chinemelu from Nigeria

Lyrics by Lucy Kiely from Australia

From January 2nd 2022 choirs and community singers will be able to download the music and recordings of the song and they can also register their involvement by clicking on this link:

<https://www.commonwealthresounds.com/qjib/qjibchoirs/>



How to take part and beacon lighting ceremony

How to take part

Step 1: To confirm your involvement and make important communication as easy as possible please register your involvement, providing the information below, direct to brunopeek@mac.com as soon as possible please, but **no later than 1st June 2022.**

If your event is a private occasion and NOT open to the public, and you do not want your involvement shown on any public or media listing, it is important that you confirm this when providing information. Your participation will still be noted as part of this historic occasion but NOT made public. However, if your event IS open to the public, your contact details will be shared with the media so that they can contact you direct to arrange any publicity and/or coverage of your event.

Name and Job Title of Contact/Coordinator
Name of Council or Organisation
Name of Piper, if applicable
Name of Bugler or Cornet Player, if applicable
Name of Town Crier, if applicable
Name and location of Choir to be registred direct to:
www.commonwealthresounds.com

Planting circle of seven trees Yes – No
Location of circle of seven trees
Postal address including county and postcode
Name of capital city - Commonwealth countries only
Country - ie England, Wales, Scotland, Northern Ireland, Channel Islands, Isle of Man, UK Overseas Territory, Commonwealth Country
Telephone number - landline
Mobile number
Email address
Beacon location - if known when registering, please include the postcode

Public or private event

Ensure you have undertaken all the legal essentials and safety requirements on page 17 before lighting your beacon. Alert the emergency services, including the Fire Brigade, undertake

any risk assessments required and ensure everyone involved is happy and familiar with your plans. (This is your responsibility as coordinator).

Beacon lighting ceremony - 2nd June 2022 Please light your Beacon at 9.45pm.

The Beacon lighting ceremony should be undertaken as follows:

Step 2: Invite your Lord Lieutenant, Deputy Lieutenant, Lord Mayor, High Sheriff, High Steward, Lord Provost, Chairman or Leader of the Council to light your beacon at 9.15pm. Alternatively, you may like to organise a competition in partnership with your local media, with the winner having the honour of lighting the beacon.

Step 3: You might consider having professional photographs taken during your event. Immediately after, please send no more than two high quality, copyright-free photographs to brunopeek@mac.com, including the name of the photographer, the beacon location, county, country and postcode, along with the name of the council or organisation.

Step 4: If appropriate, use social media channels - Twitter, Facebook etc - to promote your event. On Facebook, post photographs of your beacon lighting ceremony.

Step 5: Publicise your event. We will provide you with a Press Release template which you can localise, providing as much information as you wish regarding your event, but including your contact details. You can send this to your local media to enable them to get in touch with you direct.



Gas fuelled beacon, East Antrim, Northern Ireland.



Bonfire beacon, Killyleagh, County Down, Northern Ireland.



Wood fuelled beacon brazier, Hilton, Derbyshire, England.

Platinum Jubilee Gas-Fuelled Beacon

Bullfinch Gas Equipment

The beacon's burner-head is in the shape of a globe, representing the countries of the Commonwealth, surrounded by a Crown. It is of lightweight construction and comes assembled and complete, with the exception of the gas cylinders, which must be purchased separately. One 47kg propane cylinder or 2 x 19kg cylinders are recommended to give a full flame for a good three quarters of an hour.

These cylinders can be purchased from Flogas Britain who have been supplying Liquefied Petroleum Gas for over 35 years. They have the largest national delivery network in the UK, and hold the Carbon Trust Standard and Royal Warrant. Contact them as soon as possible to avoid delays or disappointment. Phone: **0800 574 574** or contact them via their website: www.flogas.co.uk. For their propane safety data sheet go to <https://www.flogas.co.uk/app/uploads/2-0-propane-cylinder-safety-sheet-v2-1-1.pdf>. The Gas Torch needed to light your beacon safely requires a 400g cylinder of propane with CGA600 fitting - Bullfinch No 1644 or Rothenberger or equivalent. Travis Perkins, Screwfix, Plumb Centers and some DIY stores should have these as stock items, or search online.

The Platinum Jubilee Gas-Fuelled Beacon Package contains:

- Burner unit with Crown & Platinum Jubilee insignia
- 2m high stand
- Ground anchor and rope for fixing the stand to the ground
- 10m hose with the regulator for connecting to the gas
- Gas torch for lighting
- Spanner
- Leak detecting fluid
- Hose assembly and Y manifold to link 2 cylinders
- Lighting and safety instructions

The above items are packed into 2 strong cartons. The tripod describes a circle area of about 1.32m diameter and the beacon has an extended height of about 2.15m.



The beacon is stable in the wind. It is supplied with a ground anchor and rope for securing to the ground if this is possible, or we would recommend the use of sandbags. Full instructions are provided for this. The beacon must be supervised by two people at all times when lit and a fire extinguisher must always be available. It is important that supervision should be undertaken by those who are competent and it is essential that a lighting trial



Gas-fuelled Beacon on a Church Tower.

takes place before the event to ensure that everyone is fully trained and familiar with the operation. The price of a gas-fuelled Platinum Jubilee Beacon is £490 plus VAT, including carriage to your door within UK mainland (Highlands and Islands excluded). There will be an extra charge for other areas.

Some of the benefits of this style of beacon are that it can be seen for miles once lit, is suitable for all manner of high

and low locations, is easily collapsible and once used can be stored away for later use.

To order your beacon please contact:
Bullfinch Gas Equipment,
Kings Road, Tyseley,
Birmingham, B11 2AJ.
Tel: 0121 765 2000
Fax: 0121 707 0995
Email: sales@bullfinch-gas.co.uk
Web: www.bullfinch-gas.co.uk



Payment by cheque, BACS transfer, or Credit/Debit Card. Last date to order to guarantee delivery by 29th May is 18th April 2022. However please enquire after this date for availability.

Platinum Jubilee Gas-Fuelled Beacon

21CC Group Ltd

The beacon will come ready for easy assembly, designed with a crown at the top and a special date plaque underside. The beacon will burn for approximately 1 hour using two 13kg standard propane gas cylinders, which are available from most gas stockists and petrol stations around the UK. The gas assembly is easily connected to the burner by a quick release fitting. The beacon is inherently stable; however, we recommend the use of anchors on soft ground or sandbags on hard ground for additional stability. Full set-up instructions are included within the pack and we recommend a trial set-up and lighting before the actual event to familiarise yourself with the set-up and operation. We have included two long-reach lighting sticks so that you can practice lighting the beacon in advance. We would also recommend that a fire extinguisher is available when lighting the beacon and whilst it is burning and that two people are always present.

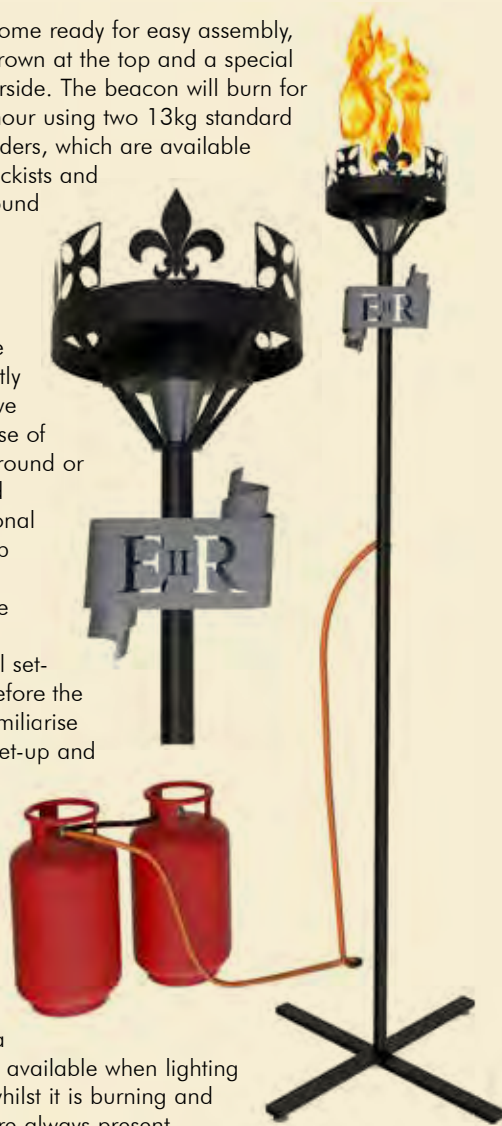

The Platinum Jubilee Beacon package contains:

- Assembly, lighting and safety instructions
- 2m high stand and burner
- 10m hose with the regulator for connecting to the gas
- Two long-reach lighting sticks
- Spanner and leak detection fluid
- Hose and Y splitter manifold to link 2 cylinders
- No additional connections required - all you need is in the box

Beacon Price:

The price of our beacon is £490 + vat, including carriage within the UK mainland. An additional charge may be applied for other areas.

Ordering & Payment

To order your Platinum Jubilee beacon, please contact 21CC Group Ltd by phone; **0131 331 4509** or email our beacon team on beacons@21ccgroup.com. Additional information can be found on our website at www.21ccgroup.com/beacons. Payment can be made in all the usual ways including BACS, cheque and credit/debit card. Orders received before **29th April 2022** will be delivered by 31st May 2022. All orders after 29th April 2022 will be taken on a case by case basis and subject to stock availability.



The lighting of a gas-fuelled beacon at Edinburgh Castle, Scotland in celebration of Her Majesty The Queen's Diamond Jubilee in June 2012.

The Queen's Platinum Jubilee Beacon Brazier

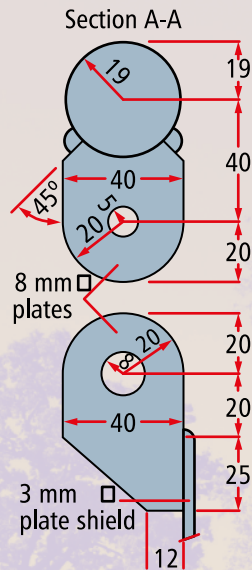
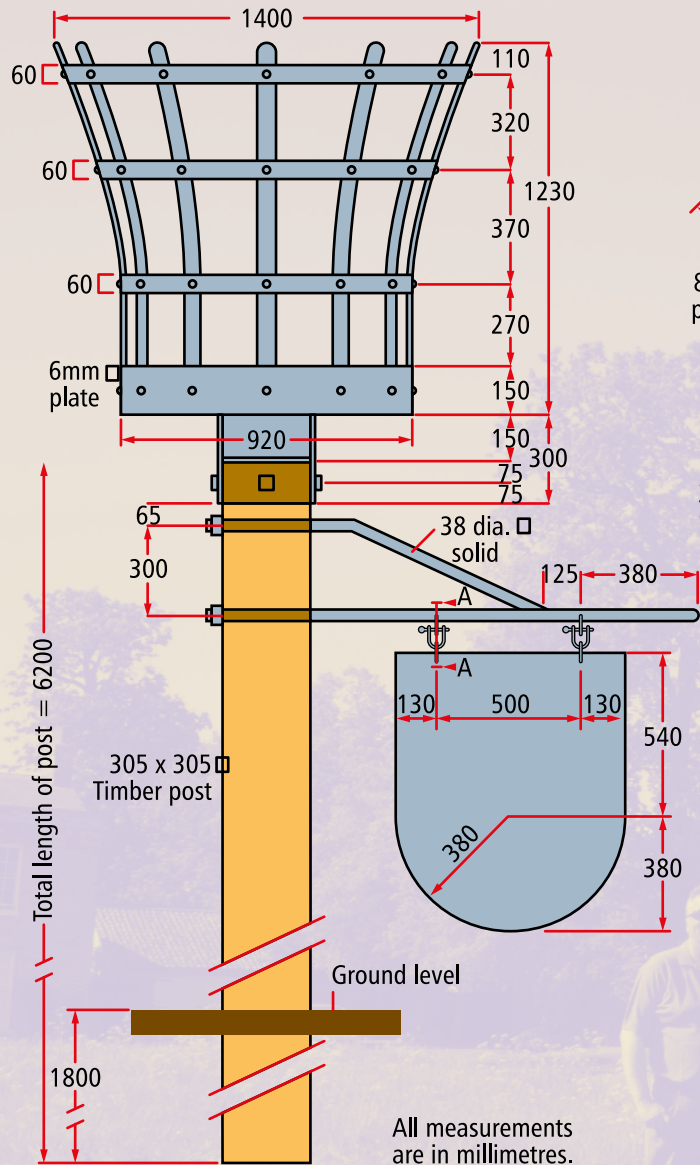

Beacon Brazier with Metal Shield

A beacon brazier will provide a permanent reminder of this unique moment in The Queen's reign. It can be built by local craftsmen and women, and may be used for future historic occasions in your community. It could be sited in a country park, on a hilltop overlooking the sea or a lake, in the centre of your town or village, and could become a tourist attraction for your area.



Materials Required for Beacon Construction

Wooden centre post consisting of 305mm x 305mm wooden post, 6.25 metres in length of which 2 metres goes into the ground.

Basket and fixing brackets consisting of:

- 1 x 920mm diameter steel plate.
- 1 x 4,178mm long 60mm x 5mm steel flat bar rolled into 1,330mm diameter ring.
- 1 x 3,455mm long 60mm x 5mm steel flat bar rolled into 1,100mm diameter ring.
- 1 x 2,985mm long 60mm x 5mm steel flat bar rolled into 950mm diameter ring.
- 1 x 2,922mm long 150mm x 5mm steel flat bar rolled into 930mm diameter ring.
- 12 x (approx 1,250mm long) 60mm x 5mm vertical bars (rolled to shape).
- 1 x 310mm x 310mm x 300mm high connection box welded to base of basket.
- 1 x hanging shield and support: 3.7m length of 38mm diameter solid steel rod.
- 1 x 920mm x 760mm steel plate 3mm thick 4 x connection brackets 8mm thick (see detailed drawings left).
- 2 x pins and loops.

Bonfire Beacon

Locate the bonfire at least 60m away from buildings, roads, railways and public rights of way, and a safe distance from dangerous materials and overhead power lines. Ensure it has good access for the transportation of materials for the bonfire and sufficient space for spectators to stand upwind.

Obtain the landowner's permission and involvement.

Liaise with your local fire brigade and all emergency services in your area, presenting them with your plans, and seek their advice and support.

1 Prepare site by removing top layer of turf and stack away from fire area. Obtain seven poles, 5-6m in length. Attach four guy ropes to top of one pole and anchor as shown.

2 Erect remaining poles as shown, ensuring tops are secured in place.

3 Use either pallets or suitable lengths of timber, spreading them over ground area of beacon for a good through draught. Secure timber horizontally between poles as shown, preventing material placed over the framework from dropping through. Construct access tunnel to the middle of the beacon. Keep middle empty

until required. Always construct the bonfire so it collapses inwards as it burns.

4 Use only wood for combustible materials. Do not burn dangerous items such as foam-filled furniture, old tyres, aerosols or tins of paint. Build upwards until height of centre pole is reached. Materials around top should be loosely packed to allow air flow. Cover bonfire to keep it dry.

5 Fill centre with suitable, dry combustible materials. Check construction is stable and remove any unsuitable materials that may have been added. Look specifically for fireworks, aerosols, highly inflammable materials or containers with such materials.

6 Construct a safety barrier out of ropes and stakes or scaffold poles to ensure public is kept at a safe distance from the fire.

7 *In daylight, and for several hours, and up to lighting, check that there are no children or animals playing or hiding in or round the bonfire. Arrange for at least 12 marshals to be in attendance, and undertake a sufficient safety briefing before lighting the beacon.*

8 The person looking after the fire should not wear lightweight clothing that could ignite easily. They should wear a substantial

outer garment of wool, or other material of low flammability, and stout boots. They should know what to do in the event of a burn injury, or a person's clothing catching fire, and should have a fire blanket ready in the bonfire area along with a number of fire extinguishers.

9 Lighting: the safest and recommended approach is to use paper and solid firelighters in six places just inside the walls of the beacon to ensure an even burn. Never use flammable liquids such as paraffin or petrol to get it going as this can result in uncontrolled spread of fire or explosion.

10 To light the beacon: from poles 2m in length, prepare hand torches for lighting with paraffin-soaked rags wired around one end. Remember, paraffin is dangerous and great care should be taken. Paraffin can be used as directed, but it is still dangerous and should at all times be treated with great care - for example, always ensure all excess paraffin is drained off rags before use. If spilt on your clothes during the preparation of your beacon lighting you should replace those items of clothing before approaching any naked flames. In particular, always remember to replace the lid on any container of unused paraffin and store it in a safe place away from naked flames. Do not use an accelerant on the fire itself.



Bonfire Beacon, Shipston-on-Stour, Warwickshire, England.

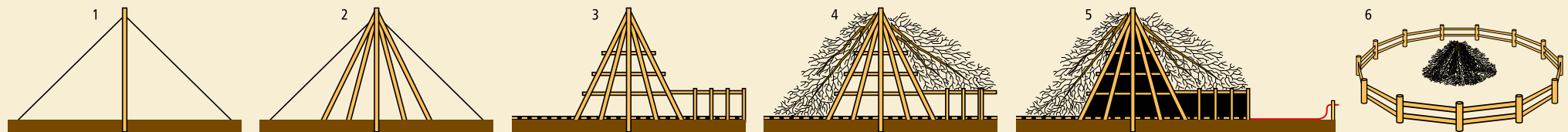

▲ After the event, extinguish fire and collect remaining debris. ▲ Dig over site and re-lay turf. ▲ Leave site clean and tidy.



Above and background: The Tower of London built by William the Conqueror in the early 1080s. Through the centuries, successive monarchs have added to the fortifications.

Legal Essentials and Safety

If you are inviting personal guests to your home it is worth checking with your household insurer that you are covered in the unfortunate circumstances that there should be an accident. If your event includes inviting the public, or it is a third party venue then, where applicable, the following advice should be heeded, to ensure you have a safe and enjoyable event for everyone involved.

Licensing

Generally, all public entertainment has to be licensed by the local authority. The law on this aims to ensure the safety of the public and performers. Local authorities treat each event individually, and what one will allow another will not. Do not be put off by the length of some of the forms - the licensing officer is there to help you.

The licensing officer's job is to advise the local authority's licensing committee on the granting of public entertainment licenses. For small scale events he or she, in effect, makes the decision. Only if your event is contentious will the licensing committee decide to consider the application in detail. Talk to the licensing officer as soon as possible. In Northern Ireland, if you plan to sell alcohol at an event, you will need to apply for an occasional liquor license from the Northern Ireland Court Service.

Insurance

Unfortunately, accidents can happen at even the best organised events. Therefore, you will need to consider and obtain insurance cover for your event, whether you are holding an event on your own premises or someone else's. beacon/bonfire events require specialist public liability cover. If you hire a park or venue or use land owned by a third party for your activity, they are likely to require you to have your own suitable insurance to cover your liability for any injury to the public or damage to other people's land or property.

If hiring equipment for the event, you may need to insure these items; you may also need to consider cover for loss of any financial outlay you incur if the event has to be cancelled for reasons beyond your control, or loss of money, particularly if you are holding a fund-raising event. Therefore, to help you obtain the appropriate insurance, and risk management advice, we are working closely with Unity Insurance Services, which is a specialist insurance broker in the voluntary and non-profit sector.

They have developed a range of bespoke insurance covers specifically for the Beacon/Bonfire events. Unity is owned by a charity and donates all its profits back to charity, so to obtain a quote or for more details or advice on the insurance cover you may need, please visit Unity's website or telephone them on 0345 040 7702.



Alternatively, the licensing officer may be able to direct you to a suitable specialist company or broker, but you should not try to source this kind of insurance from a non-specialist.



Emergency Services

Tell the police well in advance about the type of event you are planning, and get in touch with your local community police officer. Write to the fire brigade and ambulance service, particularly if you are planning to have a beacon/bonfire, fireworks, or an event that will attract a large crowd. St John's Ambulance and the British Red Cross will provide first aid and sometimes a vehicle. In some areas they are simply happy to receive a donation. In others, expect a fee to be charged.



Food and Drink

Basic food hygiene guidelines should be followed at all times if you are providing food and drink. Caterers must have food hygiene certificates. Advice on this subject can be obtained from your local council environmental officer.



Alcohol

If you want to sell alcohol you will need to secure a licence. From February 2005, licenses are granted by the local authority rather than the Magistrates Court. You should therefore contact your local authority licensing section and seek information from them on how to apply. During 2005 all existing licenses have to be renewed and this will inevitably lead to long lead-in-times. Please apply as early as possible.



Site Clearance

The local authority will arrange for clearance and disposal of litter after your event if it is on public ground (check for possible charges). You can help this process by arranging litter bins or recycling bins around the site, and a crew to clear up throughout the event.



Hiring or Borrowing Equipment

Your local authorities, or local event organisers may be able to help you with contacts for supplies such as marquees, portable toilets, barriers and bunting, or may in some cases have these for you to hire and borrow. You may also need to consider generators, a public address system, and emergency flood lighting. If you need to arrange insurance for your hired equipment, Unity Insurance Services can arrange this for you too.



All Ability Access

Access for people with a disability is very important. Many local authorities run community transport schemes. Talk to them about arranging transport. On greenfield sites, access may be improved by cutting the grass before the event.



THE QUEEN'S PLATINUM JUBILEE BEACON TRAIL

5TH MAY - 2ND JUNE 2022

If your location is lighting a beacon anywhere in the world we also encourage you to take part in this specially designed augmented reality trail that will create buzz and awareness in the four-week run up to the lighting on the 2nd of June. The Queen's Platinum Jubilee Beacon Trail will take families on a free, whistlestop tour of Her Majesty's 70 years of service.

Families and friends in locations taking part will be able to visit seven venues around their village, town or city centre, learning about a different decade in The Queen's reign at each one. Players will learn about The Queen's part in modern history as well as engaging in a fun story with characters like Sir Barnaby Beacon. Along the trail they'll meet him and his friends from Buckingham Palace, and they'll be able to see and interact with them in augmented reality.



An example trail vinyl - actual printed vinyls may vary

How It Works for Players

To take part is very simple, players don't need to download an app or even register beforehand.



Step 1

Players go online to find the trail map and visit the venues in their location, in any order.



Step 3

A digital stamp will automatically pop up on their phone's browser and tell them about that decade in The Queen's reign.

Step 4

Players can then choose to see the character in AR. This means that the character will appear life-sized in the player's environment, leading to perfect selfie opportunities and yelps of joy from children!



Step 5

Once players have collected all seven of the digital stamps, they will be given information about where and when their local beacon will be lit, and encouraged to share this with their friends and family.

How it Works for Hosts

What We Do:

- Provide all the window vinyl artworks with QR codes
- Set up your trail on the collection platform and create your digital map
- Show your trail on a central bespoke website



See me in AR >>
Scan here from a smartphone

Step 2

When they visit a venue they simply find the window vinyl and scan its unique QR code.



Cost

You can bring the trail to your location for four weeks for just £499, which includes the full artwork pack (delivered worldwide) and all digital setup and assets. This means that even if you also need to purchase one of the gas beacons, the whole event would cost under £1,000.

How to Take Part

We advise hosts to sign up as soon as possible to give adequate pre-marketing time but the deadline for applications is 7th April 2022.

To see more or to sign up as a host, please visit High Street Safari's website highstreetsafari.com/jubilee or contact the project director, Stephen Blackwell, at info@highstreetsafari.com

- Run a large scale marketing campaign
- Give you a Marketing Toolkit, specially developed for the trail
- Send you a final report on user analytics

What You Do:

- Decide where you want to put up the seven trail vinyls within your area
- Give us the list so we can create your map
- Promote the event locally using the Marketing Toolkit



The Queen's Platinum Jubilee Beacon Tart

Ingredients representing all 4 nations of the UK

England: Cheddar Cheese Northern Ireland: Potatoes

Scotland: Smoked Salmon Wales: Leek

Average cost of ingredients per tart, between £3.75 & £5.00

The following quantities will serve TEN people.

Pastry

140 g (5 oz) plain flour

35 g (1 ¼ oz) margarine

35 g (1 ¼ oz) vegetable fat

About 1 ½ tablespoons cold water

Or use ready-made shortcrust pastry

* 20 cm (8") loose-bottom flan tin

* baking beans

Filling

100 g (4 oz) Smoked salmon (trimmings or chopped small)

50 g (2 oz) leek

100g (4 oz) cooked potatoes

70g (2 ¾ oz) Cheddar cheese (grated)

200 ml (7 fl oz) single cream

2 large eggs (beaten)

1 tablespoon fresh chopped parsley

Black pepper

Butter or oil

- To make pastry - place flour in bowl add the fats and rub in lightly with fingertips until mixture resembles fine breadcrumbs. Add enough cold water to bind to a soft dough, knead briefly and shape in to a ball. Wrap and chill for 30 minutes.
- Roll out the pastry and use to line the flan tin. Prick the bottom of the pastry with a fork. Line pastry shell with foil and fill with baking beans. Place tin on a heated baking tray and bake in preheated oven at 200°C Fan (Gas 7) for 10 minutes, remove foil and baking beans, return to the oven for a further 10 minutes.
- Reduce oven temperature to 160°C Fan (Gas 4)
- Scrub potatoes and place in a pan of lightly salted boiling water to cook for 15 minutes. Drain and allow to cool before removing the skin and then slicing thinly.



- Finely chop leek. Heat a little butter or oil in a small frying pan, add chopped leek to the pan and cook over a low to moderate heat, stirring occasionally, for about 10 minutes until soft but not coloured - allow to cool.
- Mix together cream, beaten eggs, chopped parsley and plenty of ground black pepper. Layer filling in pastry case; spread smoked salmon over base of tart followed by cooked leek and then 50 g (2 oz) grated cheese (keeping remaining 20g (¾ oz) to sprinkle on top). Top with thinly sliced cooked potatoes. Sprinkle remaining grated cheese over the top then gently pour cream and egg mixture in to the tart.
- Bake in oven for 30 - 35 minutes until filling is set and golden. Serve cold.

NB These quantities also make 18 small tarts using 8cm (3 ¼") plain round cutter and lining patty tins. When making small tarts there is no need to blind bake the cases first. Bake small tarts at 160°C Fan (Gas 4) for about 30 minutes until filling is set and golden.

Guide to serving

A construction of seven Platinum Jubilee Beacon Tarts as shown below will serve 70 guests.

Each tart represents a Decade of Her Majesty's reign.

Each slice represents a Year of Her Majesty's reign.

You will need: 7 x 8" freshly made Platinum Jubilee Beacon Tarts as per recipe

7 x 8" x 0.5" silver (platinum) cake boards

1 x 20" tea tray

2 or 3 x Union Flag napkins

Optional: 2 additional silver (platinum) cake boards if greater elevation is required

Additional napkins to hand to guests with their slice of tart

Create two stacks of 3 x 8" tarts, each on a silver (platinum) cake board, and place side by side on a 20" rectangular tray covered with Union Flag napkins. Place a further tart centrally on top (7 tarts in total).

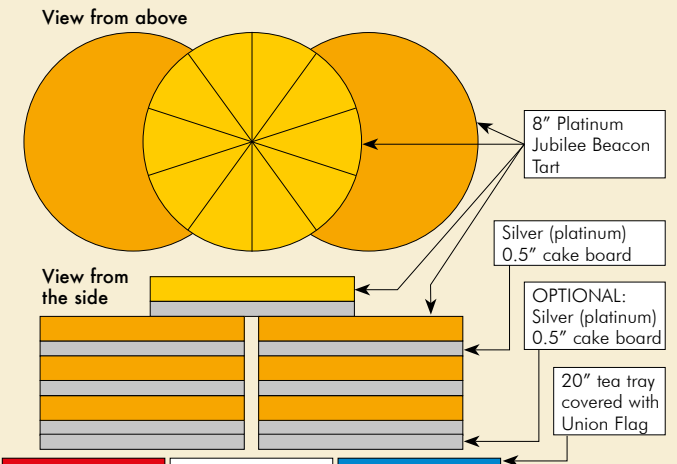

The above produces a 6" high stack of tarts. If further elevation is needed an additional cake board could be placed under each stack of 3 tarts.

Once the top tart has been ceremonially cut, remove it from the stack and set to one side to cut into ten slices. This will avoid crushing the tarts underneath. Carry out the same process for each subsequent tart, remembering to remove each one from the stack before cutting into ten. The slices can then be handed round to guests from their individual boards accompanied by napkins if desired.



The Queen's Platinum Jubilee Beacons Acknowledgements

**In recognition for their generous support in funding the design of this publication
Caravan and Motorhome Club**

**(THE LIST OF SUPPORTERS, ORGANISATIONS AND PARTICIPANTS IN ALL ACTIVITIES,
WILL BE UPDATED AT THE END OF EACH CALENDAR MONTH UNTIL 1ST JUNE 2022)**



The Association of Lord Lieutenants, Colonel Edward Bolitho OBE, Lady Dannatt MBE, High Sheriffs' Association of England and Wales, National Association of Civic Officers, Ministry of Housing, Communities & Local Government, Michael Muskett MBE, Walking With The Wounded, HM Tower of London, Sandringham Estate, The Crown Estates, Cardiff Council, Royal Borough of Windsor & Maidenhead, The Commonwealth Resounds, Sea Cadets, Army Cadet Force, Dyfed & Glamorgan Army Cadet Force, The National Cadet Corps (Accra, Ghana), Cyprus Army Cadet Force (Nicosia, Cyprus), The Royal Canadian Army Cadets (Ottawa, Canada), The Australian Army Cadets (Canberra, Australia), Air Training Corps, Backstage Technologie Europe Ltd, Night Train Productions Ltd, Huntingdon Town Council, Flogas Britain, Bullfinch Gas Equipment, English Heritage, Unity Insurance Services, Ottewill Silversmiths & Jewellers Ltd, The High Sheriff Magazine, One Voice Wales, Solace in Business, The Royal Agricultural Benevolent Institution (RABI), Local Government Association, National Farmers Union (NFU), Historic Houses, Country Land & Business Association, Isle of Wight Council, Isle of Man Government, States of Guernsey, Islands of Herm and Jethou, Council of the Isles of Scilly, Arundel Castle, Potters Leisure Resort, Norfolk Tank Museum, Oscar Research Ltd, States of Alderney, Isle of Sark Government, Unst Community Council, Tan Hill Inn, St Davids City Council, Ceremonial News, Piper Lady Jane MacRae, Piper Stuart Liddell and Piper Robert Procter, The Royal Institute of Chartered Surveyors (RICS), SLCC For Local Council Professionals, Studioeast Ltd, Great Yarmouth Borough Council, Ministry of Defence (MOD), The Ancient & Honourable Guild of Town Criers, Mr John Singer, Sir Peter Ogden, RSABI – Supporting People in Scottish Agriculture, Malvern Hills Trust/Conservators, Peter Taunton – Town Crier, The Hadrian's Wall Partnership – Lady Jane Gibson, Undeb Amaethwyr – Farmers' Union of Wales, Scottish Land & Estates, National Federation of Young Farmers' Clubs, Parish of Lanteglos & Village of Polruan, Benedict Heyes, Councillor Carl Smith, SLCC For Local Council Professionals, NFU Scotland, Brampton Parish Council, Roger Clegg – Photographer, Balmoral Estate, Edinburgh Castle, Hillsborough Castle, Highclere Castle, Inveraray Castle, Alnwick Estate, Wellington Estate, Holkham Hall, Belvoir Castle, Arundel Castle, Hatfield House, Blenheim Palace, Badminton Estate, Woburn Abbey, Floors Castle, Caledon Castle, Houghton Hall, Cholmondeley Castle, Chatsworth Estate, Bolton Abbey, Buccleuch Estate, Studio East Ltd, National Association of Local Councils, Society of Local Council Clerks, Government of Jersey, Land's End, Cornwall, Selwyn Johnstone, Northumberland County Council, Peter Taunton, Town Crier for Newport and Stafford, TMS Media Ltd, Northumberland County Council, National Farmers Union of Scotland, Country Women Countrywide, National Coastwatch Institution, Coastwatch Scotland – Irvine Unit, Piper Finlay MacDonald, Sir Brian and Lady Ivory DL – the National Piping Centre, the Corporation of Trinity House, Coastwatch Scotland – St Monans Station, Coastwatch Scotland - Irvine Station, Chiddingfold Bonfire Association, Battel Bonfire Boyes, Burgess Hill Bonfire Society, Cymdeithas Llwodraeth Leol Cymru/Welsh Local Government Association, The Royal Observer Corps, Commercial Square Bonfire Society, Northumbrian Pipers' Society, The Royal Scottish Pipe Band Association, Girlguiding, Maiden Bradley Parish Council, The Royal Scottish Pipers' Society, The Royal Celtic Society, Beverley Town Council, British Tourist Authority (BTA), VisitBritain, Silton Parish Meeting, Lincolnshire County Council.

His Grace The Duke of Norfolk, His Grace The Duke of Rutland, His Grace The Duke of Bedford, His Grace The Duke of Argyll, His Grace The Duke of Roxburgh, His Grace The Duke of Northumberland, His Grace The Duke of Wellington, His Grace The Earl of Leicester, His Grace The Earl of Carnarvon, His Grace The Duke of Beaufort, His Grace The Duke of Marlborough, His Grace The Earl of Caledon, His Grace The Duke of Devonshire, His Grace The Duke of Buccleuch, Lord Salisbury, Lord Cholmondeley, His Grace The Duke of Fife, His Grace The Duke of Somerset, Viscount Brookeborough KG KstJ, HM Lord-Lieutenant of Co. Fermanagh. His Grace The Duke of Westminster. Viscount Boyne.

(more acknowledgements to follow)

Acknowledgements



A SONG FOR THE COMMONWEALTH

The Rt Hon Patricia Scotland QC, Secretary-General of the Commonwealth
Bruno Peek LVO OBE OPR, Pageantmaster, The Queen's Platinum Jubilee Beacons
Alison Cox OBE FRSA, Founder and Chairman, The Commonwealth Resounds
Jane Hunt, Marketing and Publicity Manager, The Commonwealth Resounds
Sally-Ann Whitty, Administration Manager, The Commonwealth Resounds
Judith Weir CBE, Master of The Queen's Music and President, Royal Society of Musicians
Stephen Miles, administration and logistics management
Peter Banks – Website Consultant, Commonwealth Resounds
Colin Eade GISC Member Services – The Guild of International Songwriters and Composers
Greater Manchester Music Hub – Alison Home, Assistant Head of Wigan Music Service (Vocal)
Graham Trew MVO M.Mus, FRSA
The Composers' Society of Singapore
The African Composers' Platform
Graham Dinnage GTCL (Hons) LTCL LGSM – Choral Consultant and Mentor
Martin Coakley – Trustee and Legal Consultant for The Commonwealth Resounds



The Hillsborough Fort Guard

Sergeant Major P F Shields
(Former Major – Irish Guards)
HFG Bugler Sjt Andrew Carlisle
(Former UDR and R Irish)
Wdr Jackie McQuillan
Cpl Robert Finn
Wdr Charlie Dielt
Cpl Simon Walker
Wdr Stewart Finn
Wdr Alan Finn

Acknowledgements

Beacons



BEACONS

BEACON ANCHOR CHAIN

Royal Institution of Chartered Surveyors (RICS)

England

Deadwater Fell – **Northumberland**. Skiddaw, Nine Standards and Kirkby Stephen – **Cumbria**. Holme Moss – **Lancashire**. Mow Cop – **Staffordshire**.
Beacon Hill – Charwood, **Leicestershire**. Lyndon Hall – Oakham, **Rutland**. St Mary’s Church – Haverill, Abbey Gardens – Bury St Edmunds and Stowmarket Recreation Ground – **Suffolk**.
Blenheim Palace – **Oxfordshire**. Guiting Power, Clentenham – **Gloucestershire**.
Lands End, Chapel Carn Brea, Island of St Ives, Lower Poole Farm, Okehampton and St Agnes Beacon – **Cornwall**. North Molton – **Devon**.
Dunkery Beacon, Brean Down, Weston-super-Mare, Pen Hill, Wells and Tunley, Bath – **Somerset**. Telegraph Hill, Blackheath and Crystal Palace – **London**.
Stanhill Farm, Swanley, Meadon View – Hextable & Heron Park, The Banks, Dennes Lane, Lydd – **Kent**. Duncton Down and Ditchling Beacon, Westmeston – **Sussex**.

Scotland

Hayston Hill and Collessie – **Tayside and Fife**. Edinburgh Castle – **Edinburgh**. Criffel – **Dumfries and Galloway**.

Wales

Cefn Ysgwydd Bach, Holyhead, Faenol Famau – **Flintshire**, land adjacent to Jubilee Tower, Moel Famau, Clwydian Range.
St. David’s Head. Haverford West Showground. Amroth Beach. Parc Mawr, Penllergaer, Gower. Hill House Farm, St Mary Hill. Mynydd Baeden – **South Wales**.

Northern Ireland

Knockagh Monument – **County Antrim**.

Acknowledgements

Beacons



FOUR PEAKS

Walking With The Wounded.

England - Scafell Pike (Palgrave Ltd Seaside Good Importers & Distributors).

Scotland - Ben Nevis (Seajacks UK Ltd).

Wales - Mount Snowdon (Isadores - a boutique business and property law firm).

Northern Ireland - Slieve Donard (Stephenson Smart Chartered Accountants & Business Advisors).



OTHER BEACON LOCATIONS IN THE UNITED KINGDOM, CHANNEL ISLANDS AND THE ISLE OF MAN
(THE LIST OF BEACONS, TOWN CRIERS AND PIPERS WILL BE UPDATED AT THE END OF EACH MONTH UNTIL 1ST JUNE 2022)

ENGLAND

Avon: Yate Town Council – Tylers Field, Yate.

Bath & North Somerset: Peasedown St John Parish Council – Beacon Hill, Peasedown St John.

Bedfordshire: Woburn Abbey. Donnington Castle (English Heritage). Yelden. Clapham Parish Council – Milton Road, Clapham. Barton-le-Clay Parish Council. Potton Town Council. Moggerhanger Park Limited – Moggerhanger House, Moggerhanger Park, Moggerhanger. Shefford Town Council – Town Square, Shefford. Luton Borough Council. Renhold Village, Renhold. Leighton-Linslade Town Council – Parson's Close Recreation Ground, Leighton Buzzard.

Berkshire: Copper Horse. Windsor Great Park. Highclere Castle. Wraysbury Parish Council. Datchet Parish Council – Jubilee Green, Datchet. Seven Barrows Ltd – Faringdon Road Grass Gallops, Ferringdon. Cookham Parish Council, Cookham. Walbury Hill, Inkpen. Sunninghill & Ascot Parish Council – Victory Field, Sunninghill, Ascot. Thatcham Town Council. Thatcham.

Buckinghamshire: Latimer and Ley Hill Parish Council – Ley Hill Village Common. Waddesdon Parish Council – Waddesdon Community Centre, Waddesdon. Maids Moreton Parish Council – Maids Moreton Playing Field, Maids Moreton. Great Brickhill Jubilee Group – Great Brickhill Cricket Club, Horsepond, Great Brickhill. Hanslope Parish Council – Hanslope Recreation Ground, Hanslope. Wolverton & Greenleys Town Council – Wolverton, Milton Keynes. Great Horwood Parish Council – The Green, Great Horwood.

Cambridgeshire: Huntingdon Town Council – Castle Hill, Huntingdon. Crowland Parish Council – Snowden Fields, Crowland, Peterborough. Warboys Parish Council. Eltisley Parish Council – The Green, Eltisley, St Neots. St Nicolas Church – Hail Weston. Mary's Leighton Bromswold Parochial Church Council – top of St Mary's Church Tower, St Mary's Leighton, Bromswold, Huntingdon. Chatteris Town Council, Chatteris. Sawtry Parish Council – St Judith's Field, Sawtry, Huntingdon. City of Ely Council – St Mary's Green, Ely. Bainton and Ashton Parish Council. Soham Town Council – Recreation Ground – Soham.

Cheshire: Cholmondeley Castle. Beeston Castle (English Heritage). St Bartholomew's Church, Church Minshull, Nantwich. Beeston Parish Council – Beeston Castle – Beeston. Winsford Town Council – Rilshaw Meadows, Winsford. Guilden Sutton Parish Council – Hare Lane, Pipers Ash, Guilden Sutton. East Cheshire NHS Trust - Macclesfield District General Hospital. St Oswald's Church, Lower Peover. Barnton Parish Council, Barnton. Weaverham Parish Council – Lake House Field, Weaverham, Northwich. Toft Parish Council.

Acknowledgements

Beacons

Cornwall: Penleath Point overlooking Fowey Harbour. Pendennis Castle (English Heritage) **Not open to the public.** The Village of Polgooth – The Goffin, Polgooth. Torpoint Town Council – Rendel Park, Torpoint. Polperro Community Council. Coronation Park Trust – Coronation Park, Launceston (including firework display). Pelynt Parish Council – Tremaine Cross, Pelynt. Landewednack Parish Council – Lizard Recreation Ground, Beacon Terrace, the Lizard. East Looe Town Trust – The Wooldown, East Looe. Liskeard Town Council – Tower of St Martin’s Church, Liskeard. St Anthony-in-Meneage Parish Meeting – Roskruge Beacon. Cornwall Heritage Trust – Sancreed Beacon – Sancreed (near Penzance). Cornwall Heritage Trust – Castle an Dinas, St Columb.

County Durham: Barnard Castle (English Heritage). Fishburn Parish Council. Pitlington Community Organisation with Pitlington Parish Council – Pitlington Parish, including villages of High Pitlington, Low Pitlington and Littleton. Pitlington Community Association with Pitlington Parish Council – Littleton Green, Littleton. St Andrews Church, Winston, Nr Darlington. Boldron Parish Meeting – Boldron Village Green, Boldron, Barnard Castle. Eggleston Parish Council – Whistle Crag, Eggleston. Spennymoor Town Council – Jubilee Park, Spennymoor. Sherburn Village Parish Council – Village Green, Sherburn. Tow Law Town Council – The Millennium Green, Tow Law, Bishop Auckland. Bishop Auckland Town Council, Bishop Auckland. Darlington Borough Council – Joseph Pease Place, Darlington. Bandon & Byshottles Parish Council.

Cumbria: Brampton. Birdoswald Roman Fort (English Heritage). Whelprigg House. Mansergh Parish Meeting. Barton & Pooley Bridge Parish Council – Heughscar Hill, Nr Pooley Bridge, Ullswater. Brough Sowerby Parish Meeting – Brough Sowerby Common, Eden. Hayton Parish Council – Hayton Community Field, Hayton. Cumbria Army Cadet Force – Murton Pike, Eden. St Bees Parish Council, Egremont. Huddleston Masonic Lodge, Millom – Haverigg Airfield, Haverigg. Lamplugh and District Heritage Society – Lamplugh Hous. Levens Village – Hying Field, Levens. Norman J Thompson – Thompson Ground, Haverigg, Millom. Biggar Community Jubilee Celebrations – Biggar Village, Barrow in Furness. Crook Parish Council – Crook, Kendal. Barrow Borough Council – Clock Tower, Town Hall, Barrow-in-Furness. Barrow Borough Council – Clock Tower, Town Hall, Barrow-in-Furness.

Derbyshire: Chatsworth Estate. Hatton Parish Council – Scropton Road Recreation Ground, Hatton. Erewash Borough Council – Market Place, Ilkeston. Erewash Borough Council – Market Place, Long Eaton. Crich Parish Council – Crich Stand, Plaistow Green Road, Crich. Morley Hayes Leisure - Morley. Friends of Poulter Park – Top of the World, Poulter Park, Langwith.

Devon: Blackborough Social Club – Beacon Hill, Blackborough. Plympton Civic Society – Dorsmouth Rock, Plympton. Eggesford Airfield, Trenchard, Eggesford, Chulmleigh. Oakehampton Hamlets Parish Council. Hennock Parish Council. Luppitt Parish Council – Hartridge Common Land. Exeter City Council. Buckland Brewer Parish Council – Buckland Brewer Amenity Field, Buckland, Bideford. Delamore Estate – Penn Tor, Dartmoor. Peter Tavy Parish Council. Bideford Town Council – The Pollyfield Centre, Bideford. Strete Parish Council – 'Great Bondfire Field,' Manor Farm, Strete. Bampton Town Council – Top of Motte & Bailey, Bampton, Christow, Exeter. Moretonhampstead Parish Council – Mardon Down, Moretonhampstead. Brixham Town Council – The Green, above Shoalstone Pool, Brixham. Parish of Ilsington – Haytor Rock, Dartmoor National Park. Exmouth Town Council – Orcombe Point, Exmouth – (Planting line of 7 Trees too). Clinton Hall, Merton. Dartmouth Town Council - Jawbone Hill, Devon. Teignmouth Town Council. Teignmouth.

Dorset: Milton Abbas. Berwick St John Parish Council. Wareham Town Council. Wimborne Minster Town Council. Colehill Parish Council. Pamphill & Shapwick Parish Council - Wimborne Cemetery, Wimborne. Studland Parish Council. Blandford Forum Town Council – Railway Arches, Blandford Forum.

East Sussex: Battle (Battel Bonfire Boyes). Commercial Square Bonfire Society, Lewes. Bexhill on Sea. Willingdon and Jevington Parish Council – South Downs overlooking Willingdon. Hartfield Parish Council – Village Croft Green in the heart of the Village. Crowhurst Parish Council. Isfield and Little Horsted Bonfire Society – I.C.E. Field, Isfield. Beacon Ridge, Rye. Hamsey Parish Council – Lewes Beacon, Mount Harry, Lewes. 1st Horam Scout Group and Horam Parish Council – Horam Recreation Ground – Horam. Peacehaven Town Council, Peacehaven. Hartfield Parish Council, Hartfield. Andrew J Crotty and Brian Drayson – Galley Hill Beacon, Bexhill-on-Sea. Winchelsea Corporation / Winchelsea Millennium Artefacts Society – Winchelsea. Hastings Bonfire Society - East Hill, Hastings. Andrew J Crotty & Brian Drayson – Galley Hill, Bexhill On Sea.

East Yorkshire: Hessle Town Council – Hessle Foreshore. Bishop Burton Parish Council. Holme Upon Spalding Moor. Burstwick Parish Council and Burstwick Village Hall Management Committee – Feastive Field, Burstwick. Rowley Parish Council – High Hunsley. Millington Cum Givendale Parish Council – Swineridge in Millington Village, Millington. Fridaythorpe Parish Council – Bottom of Mere Grange, Fridaythorpe. East Cottingham Parish Council – Canal Lane, Pocklington, York.

Essex: Bulphan Recreation Ground, Essex. Alphamstone & Lamarsh Parish Council – Shrubs Farm, Lamarsh. Heybridge Parish Council – Plantation Hall, Heybridge, Maldon. Theydon Bois Parish Council - Theydon Bois Village Green, Theydon. ayne Community Group – The Swan Public House, Rayne. West Mersea Town Council – Victoria Esplanade, West Mersea, Colchester. Stapleford Abbots Parish Council – St Mary’s Church, Stapleford Abbots. Great Waltham Parish Council, Great Waltham. Great Canfield Parish Council – Great Canfield Cricket Ground, Great Canfield. High Easter Parish Council – High Easter Playing Fields, High Easter. Purfleet-on-Thames Community Forum, Thurrock Council – The Green, west side of the Royal Hotel, Purfleet-on-Thames. Stanway Parish Council – Silver Witch Green, Stanway. Billericay Town Council – Sun Corner, Billericay. Colchester Borough Council – Castle Park, Colchester.

Acknowledgements

Beacons

Wickham St Paul Parish Council – Village Green, Wickham St Paul, Halstead. Great Tey Parish Council and Village Committee – Old Playing Field, Great Tey, Colchester.
Rettendon Common, Rettendon, Chelmsford. Bradfield Parish Council - Bradfield Recreation Ground, Bradfield. Little Canfield Parish Council, Dunmow.
Loughton Town Council, Hillyfields Open Space, Loughton.

Gloucestershire: Badminton Estate. Chipping Sodbury Town Trust – The Ridings, Chipping Sodbury. St Edward's Church – Moreton-in-Marsh. Siston Parish Council – Siston Hill, Siston.
Stow on the Wold Town Council - QEII Playing Field, Stow on the Wold. Churchdown Parish Council, Churchdown. Stinchcombe Parish Council – Village Green, Stinchcombe Hill, Stinchcombe.

Greater Manchester: Tameside and Glossop Integrated Care NHS Foundation Trust (Hospital). Stockport NHS Foundation Trust - Stepping Hill Hospital. Pennine Care NHS Foundation Trust.
Oldham Council & Saddleworth Parish Council – Yarns Hill, Saddleworth (Greenfield Brass Band will be playing Die Regnare). Pennine Care NHS Foundation Trust.
Carrington Parish Council – Carrington Parish Council Recreational Field, Carrington.

Hampshire: Isle of Wight. Wellington Estate. Hurst Castle (English Heritage). Porchester Castle (English Heritage). Hythe Marina Association – The Bund, Hythe Marina. Porchester Castle.
Bramley Parish Council – Clift Meadow Park. Bramley. Portsmouth City Council – (lighting 2 Beacons). Binley Farms – Binley, Andover. Sherfield on Loddon Village Green Volunteers – Village Green,
Sherfield on Loddon, Hook. Hound Parish Council – Cricket Field, Netley Abbey, Southampton. Damerham Parish Council, Damerham. St Mary Bourne Village Centre, Andover
Pamber Parish Council – Pamber Park, Pamber Heath, Tadley. West End Parish Council, Southampton. Liss Parish Council, Liss.

Hertfordshire: Hatfield House, British Camp. Stevenage Borough Council. Aldenham Parish Council – Salters Field, Cobden Hill, Radlett. Watford Borough Council – Watford Museum, Watford.
Isle of Wight: Carisbrooke Castle (English Heritage).

Kent: Dover Castle (English Heritage), Ashford. Badlesmere Lees and Hall Committee – Badlesmere Lees (Parish Hall). Stockbury Parish Council – Church Farm, Stockbury, Sittingbourne.
Sandgate Parish Council – Esplanade, John Moore Memorial, Sandgate. Upchurch Parish Council – Upchurch Recreation Ground. Headcorn Parish Council – Days Green, Headcorn. Bethersden
Parish Council – The George Field, Bethersden. Elmsted Court Farm, Ashford. New Romney Town Council – The Greens, Littlestone, New Romney. Yalding Parish Council – Roof of St Peter & St Paul
Church, Yalding, Maidstone. Eythorne Parish Council – Eythorne Railway Station, Shooters Hill, Elvington, Dover. Horton Kirby and South Darenth Parish Council – Heathside, South Darenth. High
Halden Parish Council – High Halden Village Green, High Halden. Minster Parish Council – St Mary's Church, Church Street, Minster, Nr Ramsgate. Westgate on Sea Town Council. Hartlip Parish
Council – Hartlip Village Hall, Hartlip. Gravesham Borough Council. Appledore Parish Council. Recreation Ground, Village Hall, Historic Society etc – Appledore Recreation Ground, Appledore.
Hartley Parish Council. Hawkhurst Parish Council. Eastry Parish Council. Woodnesborough Parish Council. Lydd Town Council – The Pilot, Battery Road, Lynn on Sea, Dungeness.
Ashford Borough Council. Chittenden Farm, Staplehurst. Sevenoaks Town Council – The Vine, Sevenoaks. Chilham Parish Council – Chilham, Shottenden, Old Wives Lees. Addington Parish Council –
Addington Village Hall, Addington. Trottscliffe Parish Council – Village Hall, Trottscliffe. Brookland Parish Council – St Augustine's Church, Brookland, Romney Marsh. Crockenhill Parish Council –
Village Green, Crockenhill. Canterbury City Council – Westgate Gardens, Canterbury. Seafront, Herne Bay. Seafront, Tankerton, Whitstable. Friends of Downe Activity Centre – Downe Activity Centre,
Downe. Newchurch Parish Council – The Spinney, Romney Marsh. Hole Park Estate, Rolvenden – Windmill Farm, Rolvenden, Cranbrook. Chartham Parish Council – Chartham, Canterbury.
Brenchley and Matfield Parish Council – Matfield Green, the Green, Matfield, Tonbridge. National Trust, White Cliffs of Dover – South Foreland Lighthouse, The Front, St Margaret's Cliffe.
Swanley Town Council – Recreation Ground, Swanley. Upchurch Parish Council – Recreation Ground, Upchurch, Sittingbourne. Lamberhurst Parish Council, Lamberhurst.
(Hot Iron) on behalf of Lord Harris of Peckham (Harris Ventures Ltd) – Top field of Crockhamhill School, Edenbridge. Borough Green Parish Council – Borough Green, Sevenoaks.
Tonbridge & Maling Borough Council - Tonbridge Castle, Tonbridge. Womenswold Parish Council. Mersham Parish Council – Millennium Green, Mersham, Ashford.
Sevington with Finberry Parish Council – Recreation Ground, Sevington. Harrietsham Parish Council – St John the Baptist Church, Harrietsham, Maidstone.
Hythe Town Council – Prince's Parade Car Park, Hythe. Stockbury Parish Council - Church Farm, Stockbury, Sittingbourne. Ash-cum-Ridley Parish Council – St Peter and St Pauls Church, Ash, Sevenoaks.

Lancashire: Duchy of Lancaster, Lancaster City Council, Lancaster Priory and Lancashire Lieutenantcy Office – Lancaster Castle. Earby Town Council – Bleara Moor, Earby.
Barnoldswick Town Council. West Bradford Parish Council. Catterall Parish Council – Queen Elizabeth II Playing Field, Catterall, Garstang, Preston. Bolton Council.
Bibbs Farm Scout Camp Site and Activity Centre – Heath Charnock, Chorley. ROCA Committee – 21 Group Royal Observer Corps, Preston – Goosnargh, Preston.
Whittington Parish Council, Whittington. Grindleton Parish Council, Grindleton. Claughton-on-Brock Parish Council and Claughton Hall Estate – Cobble Hey, Claughton-on-Brock, Preston.
Browsholme Hall and Estate – Browsholme, Clitheroe. Hambleton Parish Council - Bob Williamson Park, Hamilton. Warton Parish Council – Summit of Warton Crag, Warton.
Preesall Fleetwood's Charity School – Preesall, Poulton Le Fylde. Burnley Council, Burnley.

Leicestershire: Whitwick Scout Group – Whitwick. Glenfield Parish Council – Ellis Park, off Stamford Street, Glenfield. Belvoir Castle, Barkestone Wood.
Barkby & Barkby Thorpe Parish Council. Hinckley and Bosworth Borough Council – Argents Mead, Hinckley. Stoney Stanton Parish Council, Stanton. Great Oakley Hall – Village of Saltby.
Ratby Parish Council – Tower of St Philip and St James Parish Church, Ratby.

Acknowledgements

Beacons

- Lincolnshire:** Lincoln Castle. Scrivelsby Estate/Horncastle Town Council. Pinchbeck Memorial Ground – Opposite St. Mary's Church, Church Street, Pinchbeck. Manor Farm, Howell, Sleaford. Deeping St James Parish Council – Jubilee Park, Thackers Way, Deeping St James. Elsham Parish Council. Worlaby Parish Council. Swayfield Parish Council – High Street, Swayfield. North Scarle Parish Council – North Scarle. Haxey Parish Council. Lincoln Scout Group – Thorpe-on-the Hill. Barkston and Syston Parish Council – Barkston Heath Farm, Barkston. Collyweston Parish Council – Collyweston Slater, Collyweston, Stamford. Ludford Parish Council and Ludford Village Hall and Playing Field Association – Ludford Playing Field, Ludford, Market Rasen. International Bomber Command Centre – The Memorial Spire, Bomber Command Centre, Lincoln. New Holland Parish Council, New Holland. Allington Parish Council – Allington Playing Field, Allington, Grantham. Village of Fotherby. East Lindsey. Corby Glan Parish Council – The Green, Corby Glen. South Kesteven District Council – Wyndham Park, Grantham and Dysart Park, Grantham. W. Sowerby & Co – Kirmington House, Kirmington, Ulceby. Picnic on the Green – opposite The Hub (Nocton Village Hall), Nocton. Lincoln District Scouts - Escarpment between Waddington and Harmston Village. Brigg Town Council – Millennium Green, Brigg. Winterton Town Council – Newport Drive Playing Field, Winterton. East & West Barkwith Parish Council – Car Park of Village Hall, East Barkwith, Market Rasen.
- London:** HM Tower of London. Lambeth Palace. Islington Council – Dartmouth Park, Dartmouth Park Hill. Barnet Borough Scout District, Barnet. London Borough of Haringey. Friends of Chislehurst & Walden Recreation Ground and Chislehurst Society – Walden Regreation Ground, Chislehurst.
- Merseyside:** St Helens Council – Taylor Park, Grosvenor Road, St Helens. Wirral Council, Wallasey.
- Middlesex:** 1st Hatch End Scouts in association with Hujjat Primary School - Hujjat Primary School Brookshill Harrow.
- Norfolk:** Sandringham Estate. Holkham Hall. Houghton Hall. Norfolk Tank Museum. Potters Leisure Resort. Broad Farm, Salhouse, Norwich. Tharston Events, Tharston. F.A.I.T.H Animal Rescue - Willow Brooks, Stubb Road, Hickling, Norwich. Acle Bridge Inn, Acle. Cromer Town Council – Runton Road Car Park, Cromer. Sir George Morse Park, Laundry Lane, Thorpe St Andrew, Norwich. Hockham Parish Council – Hockham Playing Field. The Lacon Arms, Seaview Road, Hemsby. Jay Jays's at the Beach Cafe, Gorleston-on Sea. South Norfolk Council – Shelfanger. Ashill Parish Council – The Green, Ashill, Thetford. Northrepps Parish Council. Rockland St Mary with Hellington Parish Council. Croxton Village Hall – Playing Field, rear of village, Croxton, Thetford. Barnham Parish Council – Barnham CEVC Primary School, Barnham. Honing Estate, Honing. Thetford Town Council – Guildhall and Market Square, Thetford. Hilgay Parish Council and Hilgay Silver Band. King's Lynn & West Norfolk Borough Council – Kings Staithe Square, South Quayside, King's Lynn. Hunstanton Town Council. North Wootton Village Hall – North Wootton. Gordon Barrett – The Harbour, The Quay, Wells-next-the-Sea. Village of East Rudham, East Runham. Caister Lifeboat Station & Caister-on-Sea Parish Council, Caister Lifeboat Station, Caister. Edgefield Parish Council, Edgefield. Fakenham Town Council – Millennium Park, Fakenham. Shelfanger Parish Council. Colby & Banningham Parish Council – Village Green, Banningham.
- Northamptonshire:** Raunds Town Council, Raunds. Brackley Town Council – Brackley RUFC Clubhouse, Brackley. Rushden Town Council – Hall Park, Rushden. Hackleton Parish Council – Piddington Cemetery, Piddington. Wootton Parish Council, Wootton, Northampton. Wilbarston Parish Council - Wilbarston Playing Field, Wilbarston. Great Oakley Hall, Great Oakley.
- North Yorkshire:** Bolton Abbey. Tan Hill Inn. Pickering Castle (English Heritage). Richmond Castle (English Heritage). Scarborough Castle (English Heritage). Spofforth Castle Easingwold Town Council. Hauxwell Hall, Leyburn. Ripon Community Poppy Project – Ripon Market Square, Ripon. Hellifield Parish Council – Hellifield Haw. Riccall Parish Council – Riccall Park, Riccall. Barlby and Osgodby Town Council – Wainhomes Playing Field. Burton in Lonsdale Parish Council. West Tanfield Village – West Tanfield. St George the Martyr Church, Scackleton, Ryedale. Eskdaleside cum Ugglebarnby Parish Council – Sleights Moor. Ripon Community Poppy Project, Ripon. Kirk Smeaton and Little Smeaton Community Event Club. Giggleswick Parish Council. Giggleswick. The Police Treatments Centre, St Andrews, Harrogate. Carthorpe Parish Council – Carthorpe, Bedale. Askham Richard Parish Council – Askham Richard Village Green, Askham Richard. Woodhouse Farm Caravan Park – Winksley, Ripon. Upper and Nether Poppleton – Village Green, Upper Poppleton. Middlesbrough – Middlesbrough Town Hall Courtyard, Middlesbrough. Crayke Parish Council, Hambleton.
- Northumberland:** Alnwick Castle. Ford & Etal Estates, Ford, Berwick-upon-Tweed – Watchlaw Farm, Berwick-upon-Tweed. Longhorsley Parish Council – Longhorsley Village Green, Longhorsley. Howick Village Hall – Hips Heugh, Howick. Green Croft Arts – HADRIAN'S WALL - Green Croft, Gilstrand, Brampton.
- Nottinghamshire:** Robin Hood Hill, Oxtun. North Leverton with Hablesthorpe Parish Council – North Leverton Mindmill Field. Walesby Forest Activity Centre – Walesby, Newark. The Military & Hospital Order of St Lazarus of Jerusalem and Ashfield District Council – The Plaza, Kirby in Ashfield. Southwell Town Council, Southwell.
- Oxfordshire:** Blenheim Palace. Henley on Thames Town Council. Westwell Parish Council. Croxden Parish Council. Brize Norton Parish Council. Highlands Farm Brightwell-cum-Sotwell – Highlands Farm, Brightwell-cum-Sotwell, Wallingford. Brightwell Baldwin Parish Meeting – Brightwell Baldwin. Grove Parish Council – Village Green, Grove. Daylesford Estate, Kingham, Chipping Norton.

Acknowledgements

Beacons

- Rutland:** Caldecott Parish Council. Barrowden Parish Council – Village Green, Barrowden. Barleythorpe Parish Council - Buttercross Park, Barleythorpe, Oakham.
- Somerset:** Rotary Club of Taunton. Burrington Parist Council. Uphill Village Society – Tower, Uphill Hill. Long Ashton Community Association – Peel Park, Long Ashton Recreation Ground, Long Ashton. Milton Clevedon Parish Council. St Cuthbert (Out) Parish Council. Winscombe and Sandford Jubilee Committee – Winscombe and Sandford. Glastonbury Town Council – Glastonbury Tor. Porlock Parish Council – Porlock Recreation Ground, Porlock, Minehead. Ripland Farm, West Hatch, Taunton. Mid Somerset Show – Mid Somerset Showground, Cannards Grave, Shepton Mallett. Kingston Seymour Parish Council – Crossman's Wharf, alongside the Bristol Channel between Clevedon and Weston-super-Mare. Somerset Young Farmers – Godney Farm, Godney, Wells. Winford Parish Council – Felton Common. West Huntspill Parish Council - Village Common, West Huntspill. Axbridge Town Council – Mendip Hills. Middlezoy Parish Council – Windmill Hill, Middlezoy, Bridgewater. Brent Knoll Parish Council & The Royal British Legion – top of Brent Knoll. Chard Town Council – Corner of junction north east of Crowshute Link and Michell Gardend, Chard. Wellington Town Council. Barleythorpe Parish Council – Buttercross Park, Barleythorpe, Oakham. Kilve Parish Council – Kilve Beach, Kilve. Stogumber Parish Council – The Beacon Field, Stogumber, Taunton. Chewton Mendip Parish Council – Chewton Down, Chewton Mendip. Somerton Town Council – Somerton Sports Club, Somerton. Churchstanton Parish Council, Taunton. Chard Town Council – Crowshute Link & Mitchell Gardens, Chard.
- South Yorkshire:** Conisbrough Castle (English Heritage). Barnsley Metropolitan Borough Council - Owd Martha's Yard Community Garden Hoyland. Maltby Town Council – Land between Victoria Street, Muglet Lane and Blyth Road, Maltby. Ulley Parish Council. Wales Parish Council. Hooton Pagnell Parish Council, Doncaster. Conisbrough Parks Parish Council, Doncaster. Ulley Parish Council. Askern Town Council – Askern Lake, Askern. Ecclestone Parish Council. Ecclestone. Penistone Agricultural Society Show – Penistone Agricultural Show Field, Penistone. Owd Martha's Yard Hoyland's Community Garden, Barnsley.
- Shropshire:** Sibdon Carwood Meeting. Trefonen Hill Walk - Mynydd Myfyr. Burwarton Estate – Summit of Brown Clee Hill (Highest point in Shropshire). Prees Parish Council – Prees Cricket and Recreation Club, Prees. Loggerheads Parish Council – Loggerheads, Market Drayton. Astley Abbots Parish Council – Cross Lane Head, Bridgnorth. Acton Burnell, Frodesley, Pitchford, Ruckley and Langley Parish Council – Burnell Bank. Sansaw Estate and Clive Parish Council – Summit of Grinshill, Clive, Shrewsbury. Greete Parish Council – Field called Lathley, Weston Court Farm, Nash, Ludlow.
- Staffordshire:** Kingstone Jubilee Group – Kingstone Parish Council. Croxden Parish Council – Wood Farm, Greatgate, Tean. Tean Leys Farm – Bagals Ordinary Worms, Leigh, Stoke of Trent. North Staffordshire Combine Healthcare NHS Trust, Stoke on Trent. Hixon Millennium Green Trust – Hixon Millennium Green, Hixon, Stafford. Brocton Parish Council, Brocton. Hixon Millennium Green Trust – Hixon Millennium Green, Hixon, Stafford.
- Suffolk:** Framlingham (English Heritage). St Peter's Church, Carlton. Ringsford and Weston Parish Council – Russell Green, Ringsfield, Beccles. Mendlesham Parish Council - Scout Site, Land adjacent to Green Road, Mendlesham Green. West Row Parish Council – Church Green, West Row. Polstead Parish Council. Eye Town Council. Southwold Town Council – Gun Hill, Southwold. Sudbury Town Council – The Croft, Sudbury. Bungay Town Council – Bigod Castle, Bungay. Benhall & Sternfield Parish Council – Aldecar Lane, Benhall. Acaster Malbis Parish Council – Acaster Malbis, York. Woolpit Parish Council – Our Ladys Well, Woolpit. Flowton Parish Meeting – Flowton, Ipswich. Levington and Stratton & Stratton Parish Council – Church Field, Levington. Little Thurlow and Great Thurlow Parish Councils, Thurlow. Kessingland Parish Council – Roy Brown Garden, Beach Road, Kessingland. Friston Parochial Church Council – Friston. Aldeburgh Town Council, Aldeburgh. Beccles Town Council – Beccles Quay, Beccles. Blundeston and Flixton Parish Council – Millennium Green, Blundeston. Wortham Burgate Parish Council – Long Green, Wortham. Lavenham Parish Council – Lavenham. Combs Parish Council – Combs Cemetery, Combs. Brandon Town Council, Brandon.
- Surrey:** Chiddingfold (Chiddingfold Bonfire Association). Woldingham Parish Council – Woldingham. Dormansland Parish Council – Dormansland Recreation Ground, Dormansland. St Barnabas Church, Ranmore Common, Dorking. Caterham Festival – Westway Common, Caterham. Pirbright Parish Council – Village Green, Pirbright. Tandridge Parish Council – Tandridge Village, Tandridge. Surrey Heath Borough Council – Frimley Lodge Park, Frimley Green, Camberley. Worplesdon Parish Council – Top of Bell Tower, St Mary's Church, Worplesdon. Lingfield Parish Council, Lingfield.
- Tyne and Wear:** Tynemouth Priory (English Heritage). Easington Lane Community Access Piont – ELCAP, Brickgarth. Salvation Army Swan Lodge – Sunderland.
- Warwickshire:** Burton Green Residents' Association, junction of Cromwell Lane and Red Lane, Burton Green. Fillongley Parish Council. The Queen's Platinum Jubilee Committee and Atherstone Town Council – Atherstone. Alcester Town Council and Alcester Royal British Legion – Alcester Centenary Field, Alcester. Warwickshire County Council – Oversley Castle, Alcester. Home Field, Park Farm, Claverdon. Stratford upon-Avon Town Council.
- West Midlands:** The Royal Orthopaedic Hospital NHS Foundation Trust – Bristol Road South, Northfield, Birmingham.
- West Sussex:** Arundel Castle. Burgess Hill Town Council & Burgess Hill Bonfire Society – St John's Park, Burgess Hill. Bognor Regis Town Council. Cowdray Estate – Cowdray Park, Midhurst. Ashurst Wood Village Council – John Pears Field, Ashurst Wood. Boxgrove Parish Council - Halnaker Windmill - Halnaker. D H Tupper Farms – Duncton Down. Southbourne Sea Scouts – Prinsted Slipway, Prinsted Shore, Prinsted, Southbourne. West Hoathly Parish Council – Finche Field, West Hoathly. Littlehampton Town Council – Littlehampton. Tillington Parish Council – Tillington Recreation Ground – Petworth.

Acknowledgements

Beacons

- West Yorkshire:** Horsforth Town Council – Hall Park, Horsforth. City of Bradford Metropolitan District Council. Friends of Cliff Recreation Ground – Cliff Recreation Ground, Holmfirth. Cookhill Parish Council – Cookhill Village Hall, Cookhill, Alcester. Kippax Parish Council – Cheney Basin, Kippax, Leeds. Calderdale Council – Halifax.
- Wiltshire:** Old Sarum. Maiden Bradley with Yarnfield. Amesbury Town Council. Netheravon Parish Council. Little Somerford Parish Council. Latton Parish Council - Playing Field, Latton. Melksham Town Council. Devizes Town Council – Roundway Hill, The Plantation, Devizes. Winterslow Parish Council – Winterslow Recreation Ground, Winterslow. All Cannings Parish Council – Cliffords Hill, All Cannings. Steeple Langford Parish Council, Steeple Langford. West Tisbury Parish Council - Newtown, West Tisbury. Burbage Parish Council – Far Lash Open Space, Farlash, Burbage. Ham Parish Council – Ham, Marlborough. Milton Lilbourne Parish Council – Martinsell Hill. The Fonthill Estate – edge of Great Ridge Woods, above village of Chicklade.
- Worcestershire:** Beacon Hill, Worcester. Spetchley Park and Gardens Estate. Spetchley Park and Gardens Estate. Wythall Community Association. Stock & Bradley Parish Council. Hanley Broadheath - Top Horse Pasture, Court Farm, Hanley, Childe. Worcester City Council - Fort Royal Park, Worcester.

SCOTLAND

- Aberdeenshire:** Balmoral Castle. Hill of Tillymorgan Gulsalmond. Turriff & District Community Council – Turriff Showground, Turriff. Inverurie Pipe Band – Bennachie Hill, Inverurie.
- Angus:** Kinnaird Castle.
- Argyll:** Inveraray Castle.
- Clackmannanshire:** Menstrie Scout Group – Top of Dumyat Hill, Menstrie.
- Dumbartonshire:** The Police Treatment Centre – Castlebrae, Auchterarder.
- Dumfries & Galloway:** Royal Burgh of Annan Community Council – Watchall Field, Annan.
- East Ayrshire:** Ochiltree Community Council - Ochiltree Community Hum, Ochiltree.
- Fife:** St Monans (Coastwatch Scotland St Monans Unit). Royal Naval Association Rosyth & West Fife Branch - Hillend Playpark. Leven Community Council – Leven Beach Promenade.
- North Ayrshire:** Irvine (Coastwatch Scotland – Irvine Unit). Beith and District Community Council. 25 Group (AYR) Royal Observer Corps Association – Slemlorlie Museum Heritage site.
- Perthshire:** Blair Castle and Cardens
- Roxburghshire:** Roxburgh Estate.
- Shetland Islands:** Unst.
- South Lanarkshire:** Rutherglen West and Wardlawhill Parish Church.
- West Lothian:** West Lothian Council – Beecraigs Country Park, Linlithgow, West Lothian.

WALES

- Brecknockshire:** Pen-y-Fan.
- Cardiff:** Cardiff Castle.
- Ceredigion:** Cyngor Cymuned Aberporth Community Council – Penrhodyn, Aberporth.
- Denbighshire:** Rhuddlan Town Council.
- Gwynedd:** Abergwyngregny Regeneration Company – Abergwyngregny. Neath Town Council – Neath Castle Gardens, Neath.
- Mid Glamorgan:** Garth Hall Farm and Garth Fawr Farm, Cilfynydd, Pontypridd. Merthy Mawr Community Council.
- Monmouthshire:** Cyngor Dinas Casnewydd/Newport City Council. Shirenewton Community Council - Recreation Field, Shirenewton.
- Pembrokeshire:** St Davids City. Marloes Community Council – Beacon Field, Marloes. Pembroke Dock Town Council. Milford Haven Town Council. Solva Community Council – Solva, Little Valley, Wiston, Haverfordwest. Neyland Town Council. Letterston Community Council, Letterston.
- Powys:** Llanfair Caereinion Town Council – Llanfair Caereinion. Llanelwedd Community Council – On Hill, at Maengowyn Farm, Llanelwedd Builth Wells. Glasbury & District Community Council.
- Vale of Glamorgan:** Penarth Town Council, Penarth Clifftops, Penarth. Llantwit Major Town Council.

Acknowledgements

Beacons

NORTHERN IRELAND

County Fermanagh: St Macartins Cathedral and along the rock shore of Enniskillen Castle, Enniskillen.

County Tyrone: Caledon Castle.

County Antrim & County Down: Lisburn and Castlereagh City Council, Lisburn

CHANNEL ISLANDS

Isle of Sark, States of Alderney,
States of Guernsey, Isles of Scilly,
Isle of Herm, Isle of Jethou,
the Government of Jersey.



ISLE OF MAN

Snaefell.

Isle of Man Federation of Young Farmers – Isle of Man.

CANADA Tea At The Whitehouse

Main Street North - Ontario



TRINITY HOUSE

Bardsey Lighthouse
Caldey Island Lighthouse
Flamborough Head Lighthouse
Longstone Lighthouse
Portland Bill Lighthouse
South Stack Lighthouse



Photograph: Lisburn & Castlereagh City Council.

The Hillsborough Fort Guard, who will be attending a Beacon lighting event, location TBC, 2nd June 2022.



Photograph: Lisburn & Castlereagh City Council.

Hillsborough Fort Guard
Sergeant Major P F Shields (Former Major - Irish Guards).

Acknowledgements

Beacons

UK OVERSEAS TERRITORIES



ANGUILLA



FALKLAND ISLANDS



ASCENSION ISLAND



GIBRALTAR



BERMUDA



SAINT HELENA



BRITISH VIRGIN ISLANDS



**SOUTH GEORGIA &
THE SOUTH SANDWICH ISLANDS**

King Edward Point, South Georgia



CAYMAN ISLANDS



TRISTAN DA CUNHA
(The world's most remote inhabited island)



CYPRUS

Episkopi Garrison



TURKS AND CAICOS ISLANDS

Acknowledgements

Beacons

COMMONWEALTH CAPITAL CITY BEACONS Regions

AFRICA

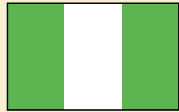

Nigeria

City - Abuja
Rotary District 9125
District Governor Ayoola Oyedokun



Ghana

City - Accra
Rotary District 9102
Past Assistant Governor Andrews Jack Dotsey



The Gambia

City - Banjul
Rotary District 9101
District Governor Christopher Forster



Tanzania

City - Dar es Salaam
Rotary District 9214
District Governor Young Kimaro



Coordinators: Rotary in London District 1130
District Governor – Selwyn Forman
Assistant Governor – Sreetharan Vallipuram

Rotary Districts involved



Sierra Leone

City - Freetown
Rotary District 9101
District Governor Christopher Forster



Botswana

City - Gaborone
Rotary District 9400
District Governor Stella Anyangwe



Uganda

City - Kampala
Rotary District 9213
District Governor John Ndamira Magezi



Rwanda

City - Kigali
Rotary District 9150
District Governor Edgar Cyr K. Tougouma



Malawi

City - Lilongwe
Rotary District 9210
District Governor Victor Mensah



Eswatini

City - Lobamba, Mbabane
Rotary District 9400
District Governor Stella Anyangwe



Zambia

City - Lusaka
Rotary District 9210
District Governor Victor Mensah



Mozambique

City - Maputo
Rotary District 9400
District Governor Stella Anyangwe

Acknowledgements

Beacons

ASIA



Lesotho

City - Maseru

Rotary District 9370

District Governor Madeleine (Maddy) Webber



Kenya

City - Nairobi

Rotary District 9212

District Governor Alex Nyaga



Mauritius

City - Port Louis

Rotary District 9220

District Governor Dinesh Gajeelee



South Africa

City - Pretoria

Rotary District 9400

District Governor Stella Anyangwe



Seychelles

City - Victoria

Rotary District 9220

District Governor Dinesh Gajeelee



Namibia

City - Windhoek

Rotary District 9350

District Governor Ian Robertson



Cameroon

City - Yaoundé

Rotary District 9150

District Governor Edgar Cyr K. Tougouma



Brunei Darussalam

City - Bandar Seri Begawan

Rotary District 3310

District Governor Dolly Yeap Siew Keat



Sri Lanka

City - Colombo

Rotary District 3220

District Governor Aruni Malalasekara

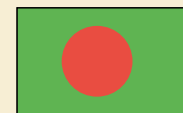

Bangladesh

City - Dhaka

Rotary District (3281)

District Governor Mutasim Billah Faruqui



Pakistan

City - Islamabad

Rotary District 3272

District Governor Saifullah Ejaz Chouhdary

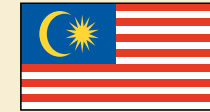

Malaysia

City - Kuala Lumpur

Rotary District 3300

District Governor Dato' Bindi Rajasegaran



Maldives

City - Male

Rotary District 3220

District Governor Aruni Malalasekara

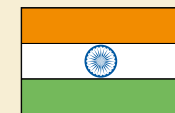

India

City - New Delhi

Rotary District 3011

District Governor Anup Mittal



Singapore

City - Singapore

Rotary District 3310

District Governor Dolly Yeap Siew Keat

Acknowledgements

Beacons

CARIBBEAN & THE AMERICAS



St Kitts and Nevis

City - Basseterre, Charlestown
Rotary District 7030
District Governor Sonya Alleyne



Belize

City - Belmopan
Rotary District 4250
District Governor Nominee Maria Price
Immediate Past District Governor Orlando Burns



Barbados

City - Bridgetown
Rotary District 7030
District Governor Sonya Alleyne



St. Lucia

City - Castries
Rotary District 7030
District Governor Sonya Alleyne



Guyana

City - Georgetown
Rotary District 7030
District Governor Sonya Alleyne



Jamaica

City - Kingston
Rotary District 7020
District Governor Louis Wever



St. Vincent and The Grenadines

City - Kingstown
Rotary District 7030
District Governor Sonya Alleyne



Bahamas

City - Nassau
Rotary District 7020
District Governor Louis Wever



Canada

City - Ottawa
Rotary District 7040
District Governor Fay Campbell



Trinidad and Tobago

City - Port of Spain
Rotary District 7030
District Governor Sonya Alleyne



Dominica

City - Roseau
Rotary District 7030
District Governor Sonya Alleyne



Grenada

City - Saint George's
Rotary District 7030
District Governor Sonya Alleyne



Antigua and Barbuda

City - Saint John's
Rotary District 7030
District Governor Sonya Alleyne

Acknowledgements

Beacons

EUROPE



Cyprus

City - Nicosia
Rotary District 2452
Deputy District Governor Peter Ashdjian



Malta

City - Valletta
Rotary District 2110
Past District Governor John De Giorgio

PACIFIC



Samoa

City - Apia
Rotary District 9920
District Governor Steve Chaney



Australia

City - Canberra
Rotary District 9705
District Governor Leo Farrelly



Tuvalu

City - Funafuti
Rotary District 9920
District Governor Steve Chaney



Solomon Islands

City - Honiara
Rotary District 9600
District Governor Wendy Protheroe



Tonga

City - Nuku'alofa
Rotary District 9920
District Governor Steve Chaney



Papua New Guinea

City - Port Moresby
Rotary District 9600
District Governor Wendy Protheroe



Vanuatu

City - Port Vila
Rotary District 9910
District Governor Grant Smith



Fiji

City - Suva
Rotary District 9920
District Governor Steve Chaney



Kiribati

City - Tarawa
Rotary District 9920
District Governor Steve Chaney



New Zealand

City - Wellington
Rotary District 9940
District Governor Mark Wheeler



Nauru

City - Yaren
Rotary District 9600
District Governor Wendy Protheroe

BEYOND THE COMMONWEALTH



Hawaii

City - Honolulu
Rotary District 5000
District Governor Sandy Matsui

Pipes & Drums - Roll of Honour

PLAYING OF DIU REGNARE

(Written by Pipe Major Stuart Liddell, Glenfiddich Champion Piper)

McCallum Bagpipes are delighted to support The Queen's Platinum Jubilee Beacons and in particular, the playing of Diu Regnare kindly written for this historic occasion by Pipe Major Stuart Liddell. Such an important milestone in The Queen's reign is of immense importance.

We are also pleased to supply a unique set of McCallum's MacRae SL4 Bagpipes by Stuart Liddell, complete with bag and maintenance kit, fully inscribed, for the piper that undertakes the playing of this unique tune from the most unusual location, at 9.09pm local time in the country they are in on 2nd June next year, as part of this unique celebration.



ENGLAND

Pipe Sergeant Ian Solesbury, City of Norwich Pipe Band – (Martham, Norfolk)
Pipe Major Simon Cater, Great Yarmouth Pipers – (Gorleston-on-Sea, Great Yarmouth, Norfolk)
Piper Allen Clement, Greenhead – (Haltwhistle, Northumberland)
Pipe Major Roger Bayes, City of Norwich Pipe Band

City of Leeds Pipe Band – (City of Leeds, West Yorkshire)

Pipe Major Andrew Neal
Pipe Sergeant Mhairi Sellar
Piper Alex Thomson
Piper Bob Green
Piper Danny Love
Piper David Danks
Piper George Anderson
Piper Gordon Laycock
Piper Jim Jack
Piper Paula Howes
Piper Richard Ashcrough
Piper Robert Lawson
Piper Robert Procter
Piper Sam Westerman
Piper Andy Tasker
Drummer Lead Tip Billy MacDonald
Drummer Amanda Liberty

Piper Robert Procter,
City of Leeds Pipe Band.



Pipes & Drums - Roll of Honour

Drummer George Harrison
Drummer Ian Turner
Drummer Stuart Richmond
Drummer Thomas Gallagher

Piper Joann Goddard (Essex)
Piper Ken Beamer (St Helens, Merseyside)
Piper Jacob Millin (Cromer, Norfolk)
Piper Ian White (Willingdon & Jevington Parish Council, East Sussex)
Piper Mungo Akerman (Brightling, East Sussex)
Piper W Miller (Kingstone, Staffordshire)
Piper Mike Mackay, No band (Inverurie, Aberdeenshire)
Piper Gerard McDonald, Reading Scottish Pipe Band (Wokingham, Berkshire)
Piper Stephen Beattie (Alsager, Cheshire)
Piper Don Earl (St. Dennis, Cornwall)
Piper Brian Ross (High Bickington, Devon)
Piper Alex Drummond, Ringwood Pipe Band (Christchurch, Dorset)
Piper Angus O'Donnell (Pocklington, East Yorkshire)
Piper Gavin Davis, Pentland Caledonia (Currie, Edinburgh)
Piper Andrew MacGregor, The Essex Bagpiper (Braintree, Essex)
Piper Joanne Goddard (Bulphan, Essex)
Piper Steve Law (Norwich, Norfolk)
Piper Jacky Barnett (Pitstone, Buckinghamshire)
Piper Corinne Thomson (Romsey, Hampshire)
Piper Laura McEwan, Scots Guards Association (South). (Totland Bay, Isle of Wight)
Piper Mark Baker, Liverpool Clan Wallace Pipe Band (Liverpool, Merseyside)
Piper Graham Botcher, Glenmoriston Pipe Band (Attleborough, Norfolk)
Piper Steve Law (Norfolk)
Piper Hugh Gillies, North Yorkshire Fire and Rescue Pipe Band (West Tanfield, North Yorkshire)
Piper Mark Harrison (Nuthall, Nottinghamshire)
Piper Rod Caird (Henley, Suffolk)

Britannia Pipe Band (Feldsted, Essex)

Piper Iain Geddes
Piper James Geddes
Piper Victoria Geddes
Piper Janet Johnston
Piper Kier Johnston
Piper Lorna Johnston

Piper Ian Anderson (Southend-on-Sea, Essex)
Piper Ken Fitzpatrick (Dunston, Gateshead)
Piper Ed Arnold, Tameside and Glossop Integrated Care NHS Foundation Trust (Ashton-Under-Lyne, Greater Manchester)
Piper Pauline Nash, Rose Fletcher Ladies Pipe Band (Moston, Manchester, Greater Manchester)
Piper Bernadette Smith, St Andrews Pipe Band (Hamble, Hampshire)
Piper David Smith (Horndean, Hampshire)
Piper Finn Miller (Winchester or North Waltham, Hampshire)
Piper Keith Wellings (Hope under Dinmore, Herefordshire)
Piper George Carr, Harpenden Pipe Band & RAF Bruse Norton Pipes and Drums (Borehamwood, Hertfordshire)
Piper Charles Mackie, Black Watch London (Dartford, Kent)
Piper Ryan Guthrie, City of Preston Pipes and Drums (Lancaster, Lancashire)
Piper Colin Murphy, Manchester Community Pipe NAND (Leigh, Lancashire)
Piper Philip Da Silva, Piper ex Preston Pipes & Drums (Lytham St Annes, Lancashire)
Piper Alan Webster (Preston, Lancashire)
Piper Iain Cairn MacGillivray Sutherland (Whittington, Carnforth, Lancashire)
Piper Sally Mason (Ancaster, Lincolnshire)
Piper Peter Abbott, Grimsby and District Pipe Band (Grimsby, Lincolnshire)

The Great Yarmouth Pipers (Gorleston, Norfolk)

Pipe Sergeant Tom Foster
Pipe Corporal Adrian Nicholls
Piper Stanley King

Piper Jan Hawkins, The Highland Pipes and Drums Ensemble (Hingham, Norfolk)
Piper John Innes (Stoke Holy Cross - Exact Location To Be Confirmed, Norfolk)
Piper Aidan Hindley, Solo (Belton, Doncaster, North Lincolnshire)
Piper John O'Boyle (New Holland, North Lincolnshire)
Piper John Anderson (Weedon Bec, Northamptonshire)
Piper William Patrick (Weedon Bec, Northamptonshire)
Piper Gill Lyons, Alnwick Pipers Society (Alnwick, Northumberland)
Piper Andrew Miller, Rothbury Highland Pipe Band (Rothbury, Northumberland)
Piper Steven Purchase, Seaforth Highlanders Notts Branch (Mansfield, Nottinghamshire)
Piper Kal Vaikla, Seaforth Highlanders Nottingham Branch (Mansfield Woodhouse, Nottinghamshire)
Piper Stuart Gullen, Seaforth Highlanders Notts&Leicester Branches (Mansfield Woodhouse, Nottinghamshire)
Piper John Roulstone (Nottingham, Nottinghamshire)
Piper Vicki Kennerley, Wolverhampton Pipeband (Nottinghamshire)

Pipes & Drums - Roll of Honour

Piper Harry Gow, Oxford Pipe Band (Brightwell-cum-Sotwell, Oxfordshire)
Piper Prof Alan F Harrison (Charlbury, Oxfordshire)
Piper William Mackenzie Smith, Reading Scottish Pipe Band (Oxford, Oxfordshire)
Piper Angus Whitfield, Oxford Caledonian Pipe Band (tbc, Oxfordshire)
Piper Casper Whitfield, Abingdon School (tbc, Oxfordshire)
Piper Tony Hurst, The Wiltshire Piper (Uffington, Oxfordshire)
Piper James Buchanan (Belton in Rutland, Rutland)
Piper Jim Stanley, Harbour Pipes and Drums (Hedge End, Southampton)
Piper Graham Prebble, RAF Pipes & Drums (TBC, TBC)
Piper Alan Robinson (Newcastle upon Tyne, Tyne and Wear)
Piper Alex Brennan, 102 R.E.M.E. Battalion Pipes and Drums. (Whitley Bay, Tyne and Wear)
Piper Peter Lambert, City of Bradford Pipe Band (Rawdon, Leeds, West Yorkshire)
Piper Dave Surtees (Chilmark, Wiltshire)
Piper Ian Mitchell (Thornton Bradford, Yorkshire)
Piper Jaqueline Mitchell (Thornton Bradford, Yorkshire)
Piper Brian McGivenor (Town Square, Shefford, Bedfordshire)
Piper Ivan Brooks – (Hartlip Village Hall, Hartlip, Kent)
Piper Tricia Drawbridge – (Sudbury Town Piper, Sudbury, Suffolk)
Piper Robert Wilson – Samlesbury Memorial Hall, Preston)
Piper James Meiklejohn (Siston, Gloucestershire)
Piper Ivan Hubbard (Bassingbourn-Cum-Kneesworth, Cambridgeshire)
Piper Bill McKay (Urmston, Manchester)
Piper Ray Russell (Thefford and Hockwold cum Wilton, Norfolk)
Piper Sue Ribson (Brightwell-cum-Sotwell, Oxfordshire)
Piper Tricia Drawbridge, Sudbury Town Piper (Sudbury, Suffolk)
Piper Roland Lawson (Carlisle, Cumbria)
Piper Ivan Brooks, Hartlip Parish Council (Hartlip, Kent)
Piper Andy Burton, Friends of Cliff Recreation Ground (Holmfirth, West Yorkshire)
Piper Robin Bartholomew, St Andrews Pipe Band, Hamble le Rice (Hamble, Hampshire)
Piper Graham MacAusland, Flt Lt RAF (Retd), (Southwold, Suffolk)
Piper David Gillingwater, Aldeburgh Town Council (Aldeburgh, Suffolk)
Piper Bernard Farmer, Bolton Caledonia Pipe Band (Irlam, Manchester, Lancashire)
Piper Andy Raeburn, Bolton Caledonia Pipe Band (Irlam, Manchester, Lancashire)
Piper Colin King, City of Preston Pipes and Drums (Preston, Lancashire)
Piper Will Bissett (Englefield Green or Windsor Great Park, Surrey)
Piper George Rokahr, Retired (Old Catton, Norwich, Norfolk)
Piper John Gabbetis, City of York Pipe Band (Stamford Bridge York, York)
Piper Pete Murray-Jones (Lee-on-the-Solent, Hants)
Piper Finlay MacGhee, International Bomber Command Centre (Lincoln, Lincolnshire)
Piper Ken Fitzpatrick (Dunston, Gateshead)

Piper Ian Pool (Telford, Shropshire)
Piper Susan Craven, Northumbrian Smallpipes (Northumberland)
Piper Matthew Harriett (Winchelsea, East Sussex)
Piper Andy Downs, Bradfield Parish Council (Bradfield, Essex)
Piper Linda Carpenter (Herne Bay, Kent)
Piper Christopher McNeilly, Hythe Town Council (Hythe, Kent)
Piper Ray Russell, Thefford Town Council (Thefford, Norfolk)
Piper Bob Ash, The Surrey Pipe Band (Woldingham, Surrey)
Piper Clint Hayes, Teignmouth Town Council (Teignmouth, Devon)
Piper Duncan Matthews, Royal Navy Pipe Band Association (Havant, Hampshire)
Piper Tom Curd (Bexhill On Sea, East Sussex)
Piper Nick Tysoe, Northampton Pipe Band (Geddington, Northamptonshire)
Piper Mark Shakeshaft, Wolverhampton Pipe Band (Wolverhampton, West Midlands)
Piper Peddar Long, Calderdale Council (Halifax, West Yorkshire)
Piper Gary Anderson, Burgess Hill Town Council (Burgess Hill, West Sussex)

Kernow Pipes and Drums

Pipe Major Nigel Warmington
Piper Adam Bowkett
Piper Matthew Campbell
Piper John Christophers
Piper Alex Dryden
Piper Craig Davidson
Piper Allan Downie
Piper Keith Garner
Piper Mike Heaslip
Piper Felicity Hood
Piper David Hutchison
Piper Don Lewis
Piper David Maitland
Piper Alec McColl
Piper Ali Robinsor
Piper Emma Stringer
Drummer Steve Dowley – Lead Tip
Drummer Henry Bowkett
Drummer Matthew Bennetts
Drummer Vic Coop
Drummer Kelvyn Cruddace
Drummer Anita Nall
Drummer Chris Nixon

Pipes & Drums - Roll of Honour

Drummer Sue Robertson
Drummer Shoalie Taylor
Drummer Ed Watson
Drummer Henry Bowkett

Northumbrian Pipers

Northumbrian Piper Andrew Davison OBE – Chairman, Northumbrian Pipers' Society – (Hexham, Northumberland)
Northumbrian Piper Tom Fairfax – (Mindrum, Northumberland)
Northumbrian Piper Freddie Fairfax – (Uppingham, Rutland)
Northumbrian Piper Dr Gill Jennifer Lyons – (Alnwick, Northumberland)
Northumbrian Piper – Philippa Sinclair
Northumbrian Piper Anne Ramsay – (Heaton, Newcastle upon Tyne)
Northumbrian Piper David Stych – (Kirby Misperton, North Yorkshire)
Northumbrian Piper Helen Capes – (President, New Zealand Northumbrian Pipers Society)
Northumbrian Piper Moira Hague – (Macclesfield, Cheshire)
Northumbrian Piper Louise Woodman (Gosforth, Newcastle-upon-Tyne)
Northumbrian Piper Susan Craven (North Broomhill, Northumberland).
Northumbrian Piper Jim Fenwick (Alnwick, Northumberland)
Northumberland Piper Neil Tavernor – (Poynton, Cheshire East)
Northumbrian Piper Carole Axford – (Chelmsford, Essex)
Northumbrian Piper Janet Allan – (Tyne and Wear, Newcastle upon Tyne)
Northumberland Piper Sally Barker – (Chatton, Northumberland)
Northumbrian Piper Thomas Ripon – (Longhoughton, Northumberland)
Northumbrian Piper Bob Turner – (Ponteland, Northumberland)
Northumbrian Piper Sophie A Fraser – (Morpeeth, Northumberland)
Northumbrian Piper Rachel Parsons – (Rendlesham, near Woodbridge, Suffolk)
Northumbrian Piper Nigel Thomas Barlow – (Forest Hall, Newcastle upon Tyne)
Northumbrian Piper Ednie Wilson – (Ryton, Gateshead, Tyne and Wear)
Northumbrian Piper John Lincoln – (Alness, Easter Ross, Scotland)
Northumbrian Piper Richard Shuttleworth – (Quebec, Canada)
Northumbrian Piper Carolyn Soakell - (Oxford, Oxfordshire)
Northumbrian Piper Brian Lawrenson (Newport-on-Tay, Fife, Scotland)
Northumbrian Piper Helen May Lawrenson (Newport-on-Tay, Fife, Scotland)
Northumbrian Piper Elizabeth Miere nee Lawrenson (Mont Es Croix, St Brelade, Jersey, Channel Islands)
Northumbrian Piper Dorothy Lawrenson (Edinburgh, Scotland)
Northumbrian Piper Michael Evans (Middleton St George, County Durham)
Northumbrian Piper Martin Luff (Totnes, Devon)
Northumbrian Piper Myrna Luff (Totnes, Devon)
Northumbrian Piper David Cook (Durham, County Durham)

Clanaulder-Clayton Pipers (Clayton, Bradford, West Yorkshire)

Piper John Balderson
Piper Keith Davey
Piper Ian Derick
Piper Ken Oldfield

City of Bradford Pipe Band (Bradford, West Yorkshire)

Piper Anne Betty
Piper Ben Gillan
Piper Bob Jenkins
Piper Peter Lambert
Piper Barbara Leddy
Piper Ian Sabiston
Drummer Adam Fenton
Drummer Jim Leddy
Drummer Andy Newton
Drummer Robert Newton
Drummer Vicky Reynolds
Drummer Paul Tyson
Drummer Val Wolff



SCOTLAND

Pipe Major Stuart Liddell, Inveraray & District Pipe Band – (Inveraray, Argyll and Bute)
Ross Ainslie – (Glasgow)
Pipe Sergeant Gordon Casely, Banchory Pipe Band –
(Nine Stanes Stone Circle, Banchory, Kincardineshire)
Piper Martin Johnstone, Piper to the Braemar Royal Highland Piping Society – (Princess Royal
Duke of Fife Memorial, Braemar, Aberdeenshire)
Piper Peter Wood – (Sandwick, Shetland Islands)
Piper William McCallum – Bearsden, East Dumbartonshire – (Cambeltown, Argyll & Bute)
Pipe Major Ben Duncan – Royal Scots Dragoon Guards Pipes and Drums
Pipers Stuart McCallum & Piper Kenzie MacLeod – McCallum Bagpipes (Kilmarnock, East Ayrshire)
Piper Archie Cowie, 9 years old – Banchory Pipe Band (From the summit of Bennachie, Aberdeenshire)

Pipes & Drums - Roll of Honour

Delgatie Castle Pipers (Delgatie Castle, Turriff, Aberdeenshire)

Pipe Major Lady Jane MacRae
Drum Major Alexander Aitken
Pipe Sergeant Stuart Thomson
Piper James Mason
Piper Richard Learmouth
Piper Andrew MacKenzie
Piper Joan Johnson
Piper Melenie Horridge
Piper Chris Horridge

Gordonstoun Pipe Band - Moray

Pipers Jacqueline Gibson
Piper Michael MacLugash (Alford, Aberdeenshire)
Piper Pamela Rotheroe-Hay, Ballater and District Pipe Band (Balmoral, Aberdeenshire)
Piper Donald Downie (West Mains of Ethie, Angus)
Piper Scott Wilson, Dunoon Argyll PipeBand (Dunoon, Argyll)
Piper Duncan MacLeod, Dunoon Argyll Pipe Band (Sandbank,, Argyll)
Piper Andrew (Drew) Crockett, Playing solo (current member of Helensburgh CC Pipe Band and formerly the Argyll & Sutherland Highlanders Pipe Band) (CARDROSS, Argyll & Bute)
Piper John Bissett (Barrhill, Ayrshire)
Piper John Stewart (Irvine, Ayrshire)
Piper Grant Angus (Crovie, Banff)
Piper John Duthie, Glasgow Highland Club (Glasgow, City of Glasgow)
Piper Alexander Brodie (Dundee, Dundee)
Piper Gavin Halliday (Glasgow, East Dunbartonshire)
Piper Flynn Porter (Lenzie, East Dunbartonshire)
Piper John McIntyre, Dunfermline & District (RBL Scot) Pipe Band (DUNFERMLINE, Fife)
Piper Brooklyn Morris, Burntisland & District Pipe Band (Hillend, Fife)
Piper Paul Hendry, Unattached (Rosyth , Dunfermline, Fife)
Piper Tabby Angier (Drumnadrochit, Highlands)
Piper Gavin Robertson, Solo Inverness British Legion Ps & Ds (Inverness, Inverness-shire)
Piper William Shaw, Last of the Summer Wine Pipers (Glasgow, Lanarkshire)
Piper Calum Macleod, Lothian and Border Pipe and Drums (Danderhall, Midlothian)
Piper Richard Montgomery, Glencorse pipe band (Mayfield, Midlothian)
Piper Alan Harrison, Comrie Pipe Band (Comrie, Crieff, Perth & Kinross)
Piper Stuart Letford (Dunkeld, Perth & Kinross)
Piper Diarmid Mackenzie Smith (Methven, Perthshire)
Piper Jonathan Stranix, City of Inverness (Ullapool, Ross and Cromarty)
Piper Andrew Wallace, Strathendrick Pipe Band (Strathblane, Stirlingshire)

Pipe Major Scott Methven, Former Queen's Piper (Thornhill, Stirlingshire)

Piper Lorna Doig (Dundee, Tayside)
Piper Martin Doig (Dundee, Tayside)
Piper Mark Morrison (Dumbarton, West Dunbartonshire)
Piper John Johnstone (Legion Hall, Wilkieston, Kirknewton, West Lothian)
Piper Ross Colquhoun, Uphall Station Pipe Band (Uphall Station, West Lothian)
Piper Gordon McCready (Renfrew, West Renfrewshire)
Piper John Paton – (Rutherglen West and Wardlawhill Parish Church - Lanarkshire)
Piper Gerry Swan (Perth, Perthshire)
Piper Lynzie Mack (Top of Dumyat Hill, Menstrie Clackmannanshire)

Banchory and District Pipes and Drums (Banchory, Aberdeenshire)

Pipe Major Andy Cowie
Piper George Alne
Piper Stuart Archer
Piper Don Black
Piper Harry Chalmers
Piper Freya Coughlin
Piper Ronny Coughlin
Piper Gordon Cruikshank
Piper Karina Dublowski
Piper Renzo Girardi
Piper Jack Hardy
Piper Kieran Hopkins
Piper Kevin Jappy
Piper Jack Lawrence
Piper Jeff Lawrie
Piper Tom Lawrie
Piper Mike Mecham
Piper Nicky Morrissey
Piper Brian Morrison
Piper John Murray
Piper Dan Pewter
Piper George Pierce
Piper Ed Richmond
Piper Lynette Ross
Piper Michael Sawston
Piper Daisy Shaju
Piper Neil Shaju
Piper Lee Taylor

Pipes & Drums - Roll of Honour

Piper Stewart Thompson
Drummer Anna Aitken
Drummer Patrick Bridges
Drummer Bryan Crighton
Drummer Neil Ferguson
Drummer Alison Geddes
Drummer Alec Hunter
Drummer Ian Mullen
Drummer Ross Munro
Drummer Bill O'Shea
Drummer Tony Sinclair
Drummer Chris Stockdale
Drummer Gordy Thompson

Pipe Major Ian Stuart, Huntly and District Pipeband (Huntly, Aberdeenshire)
Piper Raymond Munro, Solo Piper (Inverurie, Aberdeenshire)
Piper Drew McLellan, Kintyre Schools Pipe Band (Campbeltown, Argyll and Bute)
Piper Graeme Ross, Solo (Alloa, Clackmannanshire)
Piper James White, Dfs woodworks (Dumfries, Dumfries and Galloway)
Piper Ronnie Dinsmor (Baillieston, Glasgow)
Piper Duncan Lamont, HM Forces - Royal Corps of Signals (St Fillans, Crief, Perthshire)
Piper Greg Stewart, Strathendrick Pipe Band (Strathblane, Stirlingshire)
Pipe Major Mark Black, Royal Corps of Signals Pipes and Drums
Pipe Major Alan Mackenzie, Isle of Skye Pipe Band (Portree, Isle of Skye)
Piper Lewis Kinnell, Boghall and Bathgate Caledonia Pipe Band (Eliburn Livingston, West Lothian)
Piper Fiona Caldwell (Hopeman, Moray)
Piper Scott Manson (Ayr, Ayrshire)
Piper Fraser Cruikshank, Hoddum & Kinmount Estate (Lockerbie, Dumfries and Galloway)
Piper James Gillies (Midlothian)
Piper Gemma McVey, Overtown Parish Church (Overtown, North Lanarkshire)
Piper Janette Greenwood (Springs, South Ayrshire)
Piper Neil Swan, Neil Swan Piping Services (Gorebridge, MidLothian)
Piper Bob Rayson (Leith, Edinburgh)
Piper Kaya Tatar, Caledonian Piping Club (Saltcoats, Ayrshire)
Piper Alistair Graham, Dunfermline and District (RBL Scot) Pipe Band (Tillicoultry, Clackmannanshire)
Piper Ian Milne, East Kilbride Pipe Band (Rowardennan, Trossachs)
Piper Iain Cox, Troon Blackrock Pipe Band (South Ayrshire)

Piper Richard Fairnie (Stenton, East Lothian)
Piper Steven MacQueen, Lewis (Stornoway, Isle of Lewis)
Piper George McKeand, Irvine & District Pipe Band (Irvine, North Ayrshire)
Piper John Thomson (Knapp by Longforgan, Perthshire)



WALES

Pipe Major David Clement QPM, Pipes & Drums of the Tyneside Scottish TA Band – (Gowerton, South Wales)
Piper Sean Slater – (Olmarch, Ceredigion)
Piper Graham Phillips – (Pembroke Dock Town Council, Pembrokeshire, Wales)



NORTHERN IRELAND

Pipe Major Richard Parkes MBE, Field Marshall Montgomery Pipe Band
Piper Kristian Hanna, Pipes and Drums of the Police Service of Northern Ireland (Ballymena, Antrim)
Piper Grahame Harris, Campbell College Pipes and Drums (Belfast, County Antrim)
Piper Andrew Mcilwaine, Tullylagan Pipe Band (Magheramason, Londonderry)



ISLE OF MAN

Piper Vladimir Stefanov, Vlad the Piper (St. Johns, Isle of Man)
Piper Paul Davenport, Skirl Pipers (Isle of Man)
Piper Steve Cretney



JERSEY

Piper Gregor Allan, Jersey Pipe Band (St. John's Village, Jersey)

Pipes & Drums - Roll of Honour



AUSTRALIA

Pipe Major Alisdair McLaren, West Australian Police Force – (Perth)
Pipe Major Matt Fraser, Hawthorn Pipe Band – (Melbourne)
Piper Laura Johnstone, Inveraray & District Pipe Band – Sydney
Australian Federal Police Pipes & Drums (Canberra, Australia)
Pipe Major Spewen Ladd
Pipe Sergeant Nicole Koenig
Pipe Corporal Michael Challen
Drum Major Steven Terrance
Drum Sergeant Michelle Hecker
+ (12-16 Pipers & 6-8 Drummers)

Piper Alister Smith, Maclean & District Pipe Band (Maclean, New South Wales)
Piper Geoffrey Kinchin, Rainbow Celtic Folk (Taree, New South Wales)
Piper Mark Gerber (West Pennant Hills, New South Wales)
Piper Kane Johnston, Gladstone Thistle Pipe Band (Biloela, Queensland)
Piper Charlie Elliott (Brisbane, Queensland)
Piper Pete Murray (Caloundra, Sunshine Coast, Queensland)
Piper Barry Baldwin (Maroochydore, Queensland)
Piper David Moody, Ormiston Heritage Pipes and Drums (Scarborough, Queensland)
Piper Ian Reid, RSL Memorial Pipes & Drums Townsville (Townsville, Queensland)
Piper Don Ormiston, Ambulance Victoria pipes and drums (Melton, Victoria)
Piper Alistair MacCallum, Sale RSL Pipe Band (Sale Victoria, Victoria)
Piper Darral Wilkie (Hillside Garden Village, Mount Richon, Western Australia)
Piper Andrew Head (Winthrop, Western Australia)
Piper Cameron Bell, Professional Bagpipe Services - Australia (Malva Bay, New South Wales)
Piper James Black (Brisbane, Queensland)
Captain Lionel Boxer, 5/6 RVR Pipes and Drums (South Melbourne, Victoria)
Piper Christopher Tabram, The Highlands Pipes and Drums (Robertson, New South Wales)
Piper Stuart Ross (Launceston, Tasmania or Western Australia at sea)
Piper Oliver Calman (Sydney, New South Wales)
Piper Keith Blyth, City of Onkaparinga Pipe Band (McLaren Vale, South Australia)
Piper David Carr (Guildford 6055, Western Australia)

Port Macquarie Hastings Pipes & Drums (Port Macquarie, New South Wales)
Pipe Major Joy Mackenzie
Pipe Sergeant Jenny Mackenzie
Piper Terry Crossley

Piper Neil Glass
Piper Heather Lanesbury
Piper Gienn Nisbet
Piper John Rutherford
Piper Brian Stringer
Piper Anne Stroud
Drum Sergeant Kerry Austin
Drummer Hubert Biram
Drummer Joanna Buchan
Drummer Gerry Burnett
Drummer Wendy Coulls
Drummer Paul Goss
Drummer Kathy Parry
Drummer Jim Turnbull
Drummer Jim Turnbull



AUSTRIA

Piper Stefan Kühnel (Grödig, Salzburg)



BELGIUM

Piper Rudi Driesen, Clan Hay Pipe Band (Stabroek, Antwerpen)



BRAZIL

Brasil Caledonia Pipe Band

Piper Pedro Arthur Suave, (Monte Verde, Minas Gerais)
Piper Cristiano Bicudo (Campos do Jordão, São Paulo)
Piper Carlos Miranda, Brasil Caledonia Pipe Band (City of São Paulo, State of São Paulo)

Pipes & Drums - Roll of Honour



BULGARIA

Piper Susan Nicholson (My village in Bulgaria)
Pipe Major John MacKenzie, 72nd Highlanders Sofronievo (Sofronievo, Vratsa)



CANADA

Pipe Sergeant Jack Lee of Simon Fraser University Pipe Band – (British Columbia)
Piper Bruce Gandy, 78th Highlanders Halifax Citadel Pipe Band – (Dartmouth, Nova Scotia)

Ottawa Caledonian Pipes & Drums (Ottawa)

Pipe Major Robert McCarthy
Pipe Sergeant Jamie Letourneau
Piper Alysha Desrochers
Piper Thomas Rozon
Piper Ian Wyllie
Piper Sophia Oueja
Piper Noah Grew
Piper Marie-Helene Briere
Piper Giulia Calvano
Piper Zoe Gracovetsky
Piper Derek Haines
Piper Noah Yateman
Piper Kevin Murison
Piper Maia Gracovetzky
Piper Emily Dessureau
Piper Olivier Corbeil
Piper Felix Mongeon
Piper Alex Schnupp
Piper Chris Howard
Piper Justin Berube
Piper Robert McCarthy
Drum Major Darryl Lim
Drum Sergeant/Lead Drummer Allan McCarthy



Ottawa Caledonian Pipes & Drums.
Piper & Drummer Zoe and Oceanne Gracovetsky.

Pipes & Drums - Roll of Honour

Drummer Cameron Aldous
Drummer Francis Mcardle
Drummer Ray Desrochers
Drummer Marc Rozon
Drummer Dominique Moreau
Drummer Nate Mears
Drummer Owen Yateman
Drummer Connor Casey
Drummer Felicity Borgal
Drummer Sofia Calvano
Drummer Jean-Marc Schnupp
Drummer Jonathan French
Drummer Paul Fohr
Drummer Oceanne Gracovetsky

Royal Canadian Legion 63 Pipes and Drums Band

Pipe Major Brad Fenty
Piper Ron McDougall
Piper Max Redekop
Piper Glen Douglas
Piper Luke Douglas
Piper Murray Taylor
Piper Paige Knisley
Piper Adam Greuel
Piper Grayson Ross
Piper Zoe Gustafson Klassen
Piper Callie Wilk
Piper Alan Cole
Drummer Aaron Vopni
Drummer Bob Kenny
Drummer Colin Phippard
Drummer Wayne Briant
Drummer Mitch Bone
Drummer Dan Knisley
Drummer Amber Cole
Drummer Ken Martin
Drummer Jayna Munson
Drummer Olivia Guselle
Drummer Katrina Walls
Drummer Dean Mallany

Prince Albert Highlanders Pipes & Drums (Ottawa)

Pipe Major Dave Monette
Pipe Sergeant Michael McLaughlan
Piper Garry Greenshields
Piper Kim Bradley
Piper Dave Hjertaas
Drum Major Derek Sinclair
Drummer Kim Page
Drummer Roger Page

Piper Ewan Ferrier, Calgary & District Pipe Band Society (City of Calgary, Alberta)
Piper Jessie Hendrigan (Drayton Valley, Alberta)
Piper James Haslip, Damh Cabrach Piping (Edmonton, Alberta)
Piper Hon. Timothy Ray (Comox Valley, British Columbia)
Piper Gordon MacRae, BCPA (Maple Ridge, British Columbia)
Piper Stephen Kelly, 443 Squadron RCAF (Victoria, British Columbia)
Piper Craig Wight, RCMP Pipes and Drums New Brunswick (Moncton, New Brunswick)
Piper Frank Anderson (Kingston, Nova Scotia)
Piper Rory MacKinnon, Clans of Tecumseth (Alliston, Ontario)
Piper Matthew Wilson, 163 pipes and drums Hamilton (Ancaster, Ontario)
Piper John O'hara, Air Force City Pipe Band (Cobourg, Ontario)
Piper Ken Maher, Beinn Gorm Highlanders (Collingwood, Ontario)
Piper Celia Carrothers, Forest Legion Pipe Band (Forest, Ontario)
Piper Lynda Mackay, Strathnaver (Hamilton, Ontario)
Piper Douglas Green, With PWOR Pipes and Drums or as an Individual Piper (Kingston, Ontario)
Piper Doug Vince, Be.642 Legion Chatham Pipes & Drums (Louisville, Kent County, Ontario)
Piper Robert Sanders, North Bay Pipes and Drums (North Bay, Ontario)
Piper Graham Stark, Mariposa Pipes and Drums (Orillia, Ontario)

Sons of Scotland Pipe Band

Piper Graham Strachan, Sons of Scotland (Ottawa, Ontario)
Piper Bethany Bisailion, Sons of Scotland PB (Ottawa, Ontario)

Piper Brad Hampson, RCMP Pipes & Drums, National Division (Ottawa, Ontario)
Piper Christopher MacDougald, Pipes and drums of Canada/ McLarens Pipes and Drums
Warton Ont. (Shallow Lake, Ontario)
Piper Susan Ross (Stirling, Ontario)
Piper Alan Morley (Sudbury, Ontario)
Piper Joanne Robilliard, London City Pipes and Drums (Thorndale, Ontario)
Piper Scott McNeil, Ontario Correctional Services (Tiny, Ontario)
Piper Lachlann Bisailion, Royal Canadian Mounted Police C Division (Montreal, Quebec)
Piper David Mclean, Grande Prairie Pipes and Drums (Grande Prairie, Alberta)

Pipes & Drums - Roll of Honour

Bridge City Highlanders Pipes and Drums (Lethbridge, Alberta)

Piper Colin McNiven
Piper Bruce Mason

Piper James Johnston (St Albert, Alberta)

Piper John Alexander (Coombs, British Columbia)

Piper Beverly Perron (Notre-Dame-De-La-Salette, Qubec)

Piper Matt Plant, Callander Legion Pipe Band (Callander, Ontario)

Piper Ian Carruthers (Fonthill, Ontario)

Piper Lynda Lyon-Walls, Battleford Legion #9 Pipes and Drums (Battleford, Saskatchewan)

Piper Ian Rennie, Northwest Territorial Pipe Band (Yellowknife, Northwest Territories)

Piper Ann Quan (Ilderton, Ontario)

Piper Brad Heath, Northwest Territories Pipe Band (City of Yellowknife, Northwest Territories)

Piper Mary Chaisson (Haliburton, Nova Scotia)

Piper Michael Cuffe, Halton Regional Police Service Pipes & Drums (Oakville, Ontario)

Royal Canadian Legion Pipes and Drums (Callander, Ontario)

Piper Ian Fettes

Piper Barry Birosh

RCMP "J" Division Pipes & Drums (Moncton, New Brunswick)

Pipe Major M Hugh Goldie

Pipe Sgt Craig Wight

Pipe Sgt Jennifer Maillet

Pipe Cpl Pat Fox

Piper Andrew Rogers

Piper Dale Beckner

Piper Eric Mourant

Piper Joe Vautour

Piper Kevin MacLeod

Piper Mary-Anne Carlos

Piper Maurice Richard

Piper Mike Lee

Piper Scott Murray

Piper Shane Grant

Piper Walter Sutton

Drum Major Bob Bourget

Drum Sgt Larry Comeau

Drum Cpl Don Bourque

Drummer Pete Gould

Drummer Paul Spinks
Drummer Anne Keiver
Drummer Carol Fitchett
Drummer Shelena Marsh



DENMARK

Piper John Kreiner (Præstø, Zealand)



FRANCE

Piper Michel Bellebon de La Tibouvais (Quédillac, Brittany)

Piper Jean Lhuillery (Beaumontois en Périgord, Dordogne)

Piper Francois Gay, Askol Ha Brug Pipe Band (la Chapelle-sur-Erdre, Loire-Atlantique)

Piper Anne Lore, Bagad Saint-Nazaire (St Nazaire, Pays de la Loire)

Piper William Cotet, bagad Pariz (Chaville, Île de France)

Piper Yves Tyson, Lorient pipe band Brittany (Lassay sur Croisne, Center France)



THE GAMBIA

Piper Stefan Jakubowski, Gambia Police (Kotu, Kombo)

Pipes & Drums - Roll of Honour



Glen Regnitz Pipe Band, Germany.



GERMANY
Bavaria, Forchheim
Glen Regnitz Pipe Band
Pipe Major Horst Blank

Regimental Pipe Major Dominic Murphy (RTD)

Piper Wolfgang Baron
Piper Micheala Bezold
Piper Dirk Brix
Piper Sascha Bruck
Piper Gudrun Einwich
Piper Detlef Purucker
Piper Ron Rockholt
Piper Dieter Roesner

Piper Jim Shaffar
Piper Michael Vogt
Piper Olaf Wolter
Drummer Astrid Ebenau-Eggers
Drummer Andrea Koschig
Drummer Thomas Meier
Drummer Elysabeth Murphy
Drummer Jutta Rösner

Pipe Sergeant Dominic Murphy, The Glen Regnitz Pipeband (Nurnberg, Bavaria)

Piper Petra Lage (BREMERHAVEN, Northern Germany)
Piper Sean Kerr (Liesenich, Rheinland-pfalz)
Piper Christine Hanisch (Troisdorf, Rhein-Sieg-Kreis)
Piper Dagmar Pesta, The Owl Town Pipe & Drum Band Peine (Sickte, Germany)



GIBRALTAR

Piper Davie Moir, Royal Engineers (Gibraltar, Gibraltar)



HAWAII

Celtic Pipes & Drums of Hawaii

Pipe Major Larry Coleman. Pipe Major Dan Quinn.
Pipe Sergeant Tina Yap. Pipe Corporal Patrick Roberts.
Piper Lola Colombe. Piper Chuck Jamison.
Piper Greg Kim. Piper Joe Kindrich.
Piper Anne Kwiatkowski. Piper Howard Lavy.
Piper Jodi Matsuura Eaves. Piper Alan Miyamura.
Piper Hardy Spoehr. Piper Frank Talamantes.
Piper Karen Thompson. Piper Scott Walton.
Piper Pomaikai Wee. Piper Masa Yamaguchi.
Piper & Trumpetor Warren Cone.
Drum Major Joe Miller. Drum Sergeant Tracy Burnham.
Drummer Matthew Bauer. Drummer Lisa Gomes.
Drummer Elizabeth MacNeill. Drummer Kristen McNab.
Drummer Primasita Menor. Drummer Alf Schneider.

Pipes & Drums - Roll of Honour

Pipe Major Tony Reis said, "The Autshumato Anti-Aircraft Regiment Pipes & Drums will be extremely proud to be performing *Diu Regnare* from the top of Table Mountain, Cape Town, South Africa, as our tribute to Her Majesty The Queen, in recognition of her 70 years of selfless dedication to the Commonwealth."



Autshumato Anti-Aircraft Regiment Pipes & Drums, South Africa. Photograph by Tyler Williams.

Pipes & Drums - Roll of Honour



HONG KONG

Piper Fred Kew (Hong Kong)



MALAYSIA

Piper Alisdair MacRae, Kuala Lumpur Pipe Band – (Kuala Lumpur)



MALTA

Piper Gill Cairns (Tal-Pietà, Valletta)



MEXICO

Piper Diego Barquet (Mexico City)



NETHERLANDS

Piper Gerrit Krist, Clan Hay Pipe Band ('s-Heerenhoek, Zeeland)



NEW ZEALAND

Pipe Major Alasdair MacKenzie, City of Invercargill Highland Pipe Band – Invercargill)
Piper Matt Fraser – (Auckland)
Piper Terrence Smith, Royal New Zealand Navy Pipes And Drums (Auckland, Auckland)
Piper Kerry Marshall, Napier Pipe Band (Napier, Hawke's Bay).
Piper Dylan Jones, Kapiti Coast Pipes and Drums (Waikanae, Kapiti Coast)
Piper Sally Craik (Dunedin, Otago)

Piper Bryan Mitchell, Cambridge & Districts Pipe Band (Cambridge, Waipa District)
Piper Alice Robinson (Lower Hutt, Wellington)

Piper Helen Capes, New Zealand Northumbrian Pipers Society (Maraekakaho, Hawkes Bay)
Piper David Barnard, City of Wellington Pipe Band (Wellington)
Pipe Major Jim Farley, Pipes & Drums of Palmerston North & Districts (Palmerston North, Manawatu)

Wairarapa Fern and Thistle Pipe Band (Masterton, Wellington)

Piper Ian Macdonald, Piper Hunter Nielsen



NIGERIA

Piper Chukwu Oba, Scottishpower Pipe Band Nigeria, Bagpipe Music society of Nigeria (Karu LGA, Abuja)



PARAGUAY

Piper Renaud Olgati (Asunción)



PERU

Piper Alfonso Vignes-Eguren, City of Arequipa Pipe Band (Arequipa)



SOUTH AFRICA

Autshumato Anti-Aircraft Regiment Pipes & Drums

Pipe Major Tony Reis. Pipe Sergeant Mogamat Opperman
Piper Terence Hutton. Piper Michael Leighton. Piper Emlyn Madziwa. Piper Emily Craven
Piper Kuhle Mankayi. Piper Luke Marais. Piper Neil Horn. Piper Anton van der Poel
Piper Wayne Mitchell. Piper James Mitchell
Drummers: Thabiso Teesow, Lesley Reis, Zhaheed Smith, Melanie Tafila, Mivuyo Khete,
Mihlali Nguzo, Maajidah Opperman, Theo Caesar, Eugene Trofimczyk,
Brogan Reis, John Van Niekerk, Ronnie Masenda

Pipes & Drums - Roll of Honour

Piper Alan Munro, Scottish Piping Society of South Africa (San Sereno Retirement Village, Johannesburg)
Piper Capt. Will Carter JCD KLJ (Cape Town, Western Cape)
Piper Mark Anthony Wilson, Cape Town Highlanders (Cape Town, Western Cape)
Piper Lucas Visagie (Paarl, Western Cape)
Piper Paul Louw, African Skye Pipe Band (Johannesburg, Gauteng)
Piper Alan Munro, Scottish Piping Society of South Africa (Johannesburg, Gauteng)
Piper Rory Mackenzie, Pietermaritzburg Caledonian Pipe Band (Hilton, KwaZulu-Natal)
Piper Caireen Alston, Nelson Mandela Artillery Pipes And Drums (Cape Town, Western Cape)
Piper Peter Odendaal, Knysna and Districts Pipe Band (Somerset West, Western Cape)



SWITZERLAND

Piper Damien Bell, Scotch Watch Pipes & Drums (Seelikon Bade, Zug)



THAILAND

Piper Keith Walker, The British Club Bangkok Pipe Band (Bangkok)



UNITED STATES OF AMERICA

Piper Jeff Simmons, Contractor (Tucson, Arizona)

Piper Tammy Simmons (Tucson, Arizona)

Piper Jason Gunn, Universal Bagpipes (St Joe, Arkansas)

Palm Springs Air Museum Pipe Band (Palm Springs, California)

Pipe Major Robert Heggie

Pipe Sergeant Shaun Griffith

Piper Graham Bailey

Piper Len Box

Piper Joe Branston

Piper Daniel Butchard

Piper Harold Butchard

Piper Rod Cribbes

Piper Joel Daniel
Piper Mike Fitak
Piper Jeff Geraci
Piper Jack Grant
Piper Colin Grinstead
Piper Jim MacKenzie
Piper Don MacPherson
Piper Jim McKnight
Piper Jon McLennan
Piper Mel Miller
Piper Bill Partridge
Piper John Ralston
Piper Tom Skinner
Piper Maureen (Mo) Soichuk
Piper Bill Tracey
Piper Ken Wright
Piper Richard Young
Drum Major Pierre McIntyre
Drum Sergeant Malcolm Willis
Drummer Thad Ball
Drummer Christi Bennett
Drummer Fabian Hurtado
Drummer Rusty King
Drummer Lavon Marie
Drummer Pamela McIntyre
Drummer Toner Nailen
Drummer Tony Parise
Drummer Marty Stacksteder
Drummer Trevor Uprichard

Piper Dr. Gary Dickey (Westlake Village, Ventura County, California)
Piper Kenneth Feighner, Colorado Irish Pipe Band (Berthoud, Colorado)

Saint Andrew's Pipe Band of Miami (Miami, Florida)

Piper Nigel MacDonald

Piper Barbara Wach

Pipes & Drums - Roll of Honour

Piper Michael Vazzana, McGuire's Irish Pub Pipe Band (Pensacola Beach, Florida)
Piper Richard Smith, Appalachian Saint Andrew's Pipes and Drums (Blairsville, Georgia)
Piper Dennis Duncan, Marietta Piper (Marietta, Georgia)
Pipe Major Kim Greeley, Celtic Kula Pipe Band of Hawai'i (Honolulu, Hawai'i)
Piper Jack Lewis, Danville Pipe Band (now defunct) (Mount Vernon, Kentucky)
Piper David Cormalleth, ChicagoBagpiper.com//Bagpipers of the World United (Lake Forest, Lake County, Illinois)
Piper Rob Haskell (Peabody, Massachusetts)
Piper Frederick Benda, Springfield Kiltie Pipe Band, Springfield Massachusetts, United States (Westfield, Massachusetts)
Piper Dana Deweese, Solo (Jefferson City, Missouri)
Piper Brian J. Gibney (Bridgewater, New Jersey)
Piper Sara Hufford, Order of the Thistle Pipe Band (Santa Fe, New Mexico)
Piper Kathleen Wright (North Kingsville, Ohio)
Piper Scott McKinley, Oklahoma State University Pipes and Drums (Stillwater, Oklahoma)
Piper Michael Hubbard, Clan Macleay Pipe Band (Salem, Oregon)
Piper Jean Lickun (Lords Valley, Pike County, Pennsylvania)
Piper Edwin Gonzalez, VMHG Piper (Sumner, Pierce Washington state)
Piper Molly Navarro-Skinner, The Jefferson Pipe Band (Redding, Shasta County, CA)
Piper Matthew Reeder, City of Chattanooga Pipe Band (Chattanooga, Tennessee)
Piper Kelly Shipe, A HARP AND BAGPIPE FOR ALL OCCASIONS (Gatlinburg, Tennessee)
Piper Laurence Ching, Houston Highlanders Pipes and Drums (Alvin, Texas)
Piper Adam Wilcox (Amarillo, Texas)
Piper Matt Willis, Metroplex United Pipe Band (Carrollton, Texas)
Piper Charlie Nevegold, Sherman Fire-Rescue Pipe Band (Ector, Texas)
Piper Colleen Steblein, North Texas Caledonian Pipes and Drums (Ft. Worth, Texas)
Piper Brenton Scharbor, Allegro Pearland Academy of Music (Pearland, Texas)
Piper Paul Watson (Tyler, Texas)
Piper Hunter Nichols (Whitewright, Texas)
Piper Chris Dries (Mt. Pleasant, Utah)
Piper Anne L Storms (Salt Lake City, Utah)
Piper Alan Erdmann, Salt Lake Scots (Springville, Utah)
Piper Victoria MacKenzie, Fort Vancouver Pipe Band (Vancouver, Washington)
Piper Michael Grest, Atlanta Pipe Band (Auburn, Georgia)
Piper Colin Gavin, Firefighters Highland Guard of Naperville (Naperville, IL)
Piper Douglas Walton (Marquette, Michigan)
Piper Tyler Johnson, Wasatch and District Pipe Band (Kaysville, Utah)
Piper Tim Riddle (Edgewood, WA)
Piper Robert J McFarland DDS (City of Boise, Ada County, State of Idaho)
Piper Bob McFarland, Northumbrian Small Pipes (Boise, Idaho)

Piper Frank Bonneau, Piedmont Pipers (Portland, Oregon)
Piper Isaac T. Benda, Springfield Kiltie Pipe Band (City called Adams, Massachusetts)
Piper Charles Martin, Pipes & Drums of CAL FIRE L2881 (Ukiah, California)
Piper Daniel Johnson (Louisville, Kentucky)
Piper Jim Roberts, Tidewater Pipes & Drums (Williamsburg, Virginia)
Piper Baxter Holland, (Rutland, Vermont)
Piper Neil Keppie, Saint Andrew's Pipe Band of Miami (Miami, Florida)
Piper Peter Rolstad, (Bellingham, Washington)
Piper MSG (R) Mace Marti, Bushwackerbagpiper (Cheyenne, Laramie County, Wyoming)
Piper Colonel Milan Kobulnicky, Williamsburg Pipes and Drums (Williamsburg, Virginia)
Piper Andrew Nowaczyk (Poulsbo, Washington)
Piper Steven Lemieux (Augusta, Maine)
Piper Cathleen Nixon, North American Academy of Piping & Drumming (Grandfather Mountain/Linville, North Carolina)
Piper Christopher Schiffer, Solo (Faribault, Rice County, Minnesota)
Piper Meghan Hutchins, Williamsburg Pipes and Drums (Williamsburg, Virginia)

The Jefferson Pipe Band (Redding, California)

Pipe Major Rob Jeffs
Pipe Major Bob Skinner
Drum Major Scott J. Thomsen
Piper Dave Alexander
Piper Bob Budes
Piper John Burke
Piper Dave Cave
Piper Caleb Cox
Piper John Elliott
Piper Dan Flores
Piper Gavin Guidotti
Piper Ted Hales
Piper Paul LaPrise
Piper Linda Lindsay
Piper Nancy Menefee
Piper Becky Saraceno
Piper Don Saraceno
Piper Brian Schwartzberg
Piper Carrie Wigham
Piper/Drummer Molly Navarro-Skinner
Drummer Becky Cox
Drummer Rick Fernandez

Pipes & Drums - Roll of Honour

Drummer Caleb Guidotti
Drummer Phil Guidotti
Drummer Lori Martin
Drummer Brandon Muck
Drummer Jax Robertson
Drummer Bob Smith
Drummer Darin Talcott
Drummer Ethan Walsh
Drummer Dion Williams

Williamsburg Pipes and Drums (Williamsburg, Virginia)

Piper Bill Price
Piper Hannah Carpenter
Piper Evan Blinn
Piper Lexey Donohue
Piper Meghan Hutchins
Piper CJ Ortolano-Collins
Piper Milan Kobulnicky
Piper Joe Burns
Piper Scott Swan
Piper Charles Perry
Piper Lynn Newcomer
Piper Jim Boyer
Drummer Tim Cordle
Drummer Bill Yates



ZIMBABWE

Piper Callum Smith, St Johns College Pipe Band (Harare)

(more acknowledgements to follow)

Town Criers - Roll of Honour

Chelsea Pensioner Roy Palmer will undertake the Proclamation at the Royal Hospital Chelsea.



Photograph by kind permission of Liam Best, Marketing & Communications Manager, Royal Hospital Chelsea.

PROCLAMATION BY TOWN CRIERS (Written by Jane L. Smith, Town Crier for Bognor Regis)



ENGLAND

- Alan Austin - Town Crier (Attleborough, Norfolk)
- Andrew Cunningham-Brown – Town Crier (Sherringham, Norfolk)
- Nigel Wilkin – Town Crier (Swaffam, Norfolk)
- Jason Bell – Town Crier (Holt, Norfolk)
- Bob Lloyd – Town Crier (City of Norwich)
- Brenda Wilson – Town Crier (Newmarket, Suffolk)
- Peter Taunton – Town Crier (Newport & Stafford, Shropshire)
- Jane L Smith – Town Crier (Bognor Regis, West Sussex)
- Marion Lowe – Town Crier (Shipston on Stour, Warwickshire)
- Paul Goring – Town Crier & Town Seargent (Rye, East Sussex)
- Jon Borthwick – Town Crier (Peacehaven & Lewes, East Sussex)
- Jackie Edwards – Town Crier (Kingsteignton, Devon)
- Len Sweales – Town Crier (Wells, Somerset)
- Ken Brightwell – Town Crier (Cheltenham, Gloucestershire)
- Mike Dale – Town Crier (Lenham, Kent)
- Brian Slyvester – Town Crier (Newbury, Berkshire)
- Terry Hamer – Town Crier (Romsey, Hampshire)
- Richard Smith BEM – Town Crier (Beaconsfield, Buckinghamshire)
- Mike Wabe – Town Crier (Watton, Norfolk)
- David Green – Deputy Town Crier (Plymouth and Mayflower Resurgam, Devon)
- David Birdsall – Town Crier (Scarborough, North Yorkshire)
- David Hinde – Town Crier (Helmsley, North Yorkshire)
- Robert Speight – Town Crier (Pershore, Worcestershire)
- Stephen Day – Town Crier (Kidderminster, Worcestershire)
- Michael Wood – Town Crier & three times World Champion (East Riding of Yorkshire)
- Les Long – Town Crier (Henley-in-Arden, Warwickshire)
- John Collingwood – Town Crier (Bridport, Dorset)
- Chris Smirthwaite – Town Crier (Liskeard, Cornwall)
- Jon Bartholomew – Town Crier (Hastings, East Sussex)
- David Bull – Town Crier (Filey, North Yorkshire)
- Christopher Morgan – Town Crier (Leighton & Linslade, Bedfordshire)
- Alistair Chisholm – Town Crier (Dorchester, Dorset)
- Avril Hayter-Smith – Town Crier and Consort Graham Hayter-Smith (City of Ely, Cambridgeshire)
- Peter Stemmer BEM – Town Crier of and Ambassador for (Darlington, County Durham)
- Harry Turburville – Junior Town Crier (Thetford, Norfolk)

Town Criers - Roll of Honour

Michael Bluemel – Deputy Town Crier (Rye, East Sussex)
Paul Gough – Town Crier and Reining British Champion TC (Nuneaton & Bedworth, Warwickshire)
Terry Williams – Town Crier (Bodmin, Cornwall)
Carole Williams – Town Crier (Bishops Stortford, Hertfordshire)
Steve O'Dare – Town Crier (Skegness, Lincolnshire)
Chris Brown – Town Mayor's Sergeant & Town Crier of (Wimborne Minster & Colehill, Dorset)
Cris Brown – Town Crier (Royal Borough of Windsor & Maidenhead, Berkshire)
Andrew Stopka – Town Crier (Fairford, Gloucestershire)
Nigel Scott – Town Crier (Axbridge, Somerset)
Jacquie Hall – Town Crier (Wareham, Dorset)
Trevor P Heeks – Town Crier & Freeman (Trowbridge, Wiltshire)
Dave Parsons – Town Crier (Alton, Hampshire)
Jim Weeks – Town Crier (Bideford, Devon)
Mike Billingham – Town Crier (Medway, Kent)
John Lawrence – Town Crier (Cirencester, Gloucestershire)
John Scholey FICE – Town Crier (Royal Tunbridge Wells & Westerham, Kent)
Ray Wales – Town Crier (Downham Market, Norfolk)
Bill Lomas – Town Crier (Leek, Staffordshire)
Angela Standing – Town Crier (Arundel, West Sussex)
Bob Smytherman – Town Crier (Worthing, West Sussex)
Barry McQueen – Town Crier (Blackpool, Lancashire)
Barry Heap – Town Crier (Richmond, North Yorkshire)
Kevin Reid Griffiths – Town Crier (Skipton, North Yorkshire)
Rawden Kerr – Town Crier (Great Harwood, Lancashire)
Robert Needham BA – Town Crier (Colchester, Essex)
Martin Wood – Town Crier (Shrewsbury, Shropshire)
Les Cutts – Town Crier (Halifax, West Yorkshire)
George Carpenter – Town Crier (Wotton under Edge, Gloucestershire)
Terry Ford – Town Crier (Otley, West Yorkshire)
Mike Andrews – Town Crier (Ferndown, Dorset)
Chris Brown – Town Mayor's Dergeant & Town Crier (Wimborne Minster & Colehill, Dorset)
John Hadfield – Town Crier (Westbury, Wiltshire)
Majorie Dodds – Town Crier (Chester-le-Street, County Durham)
Roger Hewitt – Town Crier (Knaresborough, North Yorkshire)
Vic Watson – Town Crier (Huddersfield, West Yorkshire)
Lionel Knight – Town Crier (Truro, Cornwall)
Don Evans – Town Crier (Ormskirk, West Lancashire)
Geoffrey Russell – Town Crier (Market Drayton, Shropshire)
Charles Morgan – Town Crier (Bishopsteignton, Devon)
Jane Dodd – Town Crier (Chesham, Buckinghamshire)

Jason Ede – Town Crier (Newhaven, East Sussex)
Simon Bartlett – Town Crier (Bampton and Huntsham, Devon)
David Bradshaw – Town Crier (Newquay, Cornwall)
Andrew Downing – Town Crier (Stamford, Lincolnshire)
Martin Payne – Town Crier (Bungay, Suffolk)
Peter Powell – Town Crier (Lymm Cross, Cheshire)
Karen Bailey – Town Crier (Swadlincote, Derbyshire)
John Parsons – Town Crier (Macclesfield, Cheshire)
David Charles Milton – Town Crier (Watchet, Somerset)
John Griffiths – Town Crier (Sleaford, Lincolnshire)
Elizabeth Anderson-Watson – Town Crier (Barnoldswick, Lancashire)
Steven Holt – Town Crier (Morley, West Yorkshire)
David Summers – Town Crier (Mablethorpe & Sutton, Lincolnshire)
Alan Spencer – Town Crier (City of Southampton, Hampshire)
Joseph David – Town Crier (Hinkley, Leicestershire)
Roy Palmer – Town Crier (Royal Hospital Chelsea, London)
Hilary McGrath – Town Crier (Garstang, Lancashire)



*Michael Wood, Town Crier,
East Riding of Yorkshire.*

Town Criers - Roll of Honour

Michael Hickmott – Town Crier (Tenterden, Kent)
Kevin N Ward – Town Crier and Bellman (Court Leet & Court Baron of the Manor of Bromsgrove)
David Peters – Town Crier & Beadle (Guildford)
Michael Reddy – Town Crier (Warwick)
Mark Northway - Town Crier (Cromer, Norfolk)
Sharon Wilson – Town Crier (Saltburn by the Sea, North Yorkshire)
Alan Giles - Town Crier (Fowey, Cornwall)
Alan Myatt – Town Crier (Camden Market, Covent Garden, London, City and Port of Gloucester)
David Burrows – Town Crier (Southwold)
Chris Conlan – Town Crier (Sevenoaks, Kent)
John Bateson – Town Crier (Kendal, Cumbria)
Francesca Fitch – Town Crier (Town Square, Shefford, Bedfordshire)
Michael Eldred - Town Crier (The Swan Public House, Rayne, Essex)
David Greenway – Town Crier (Glastonbury Town Council, Somerset)
Grant Dennis – Town Crier (Porlock Parish Council, Porlock, Minehead, Somerset)
Leslie Ellis - Town Crier (Dartmouth, Devon)
Peter Dauncey – Town Crier (Melksham Town Council, Wiltshire)
Roger Bourgein – Town Crier (Exmouth Town Council, Devon)
Peter Stemmer – Town Crier (Darlington Borough Council, Darlington, Co. Durham)
Karen Crow – Town Crier (City of Lincoln, Lincolnshire)
Steve Davis – Town Crier (Somerton Town Council, Somerton, Somerset)
Alan Robert Brown – Town Crier (Dalton and Barrow-in-Furness, Cumbria)
Patrick Brophy – Town Crier (Teignmouth Town Council, Devon)



SCOTLAND

Councillor David Coleman & Bugler Mr Michael Hunter (Fife)



WALES

Susie Blower – Town Crier (Montgomery, Powys, Wales)
David Salter – Town Crier (Llanfair Caereinion, Powes)
Bob Williams – Town Crier (Pontardawe, Swansea)
Janet Swindale – Town Crier (Llandrindod Wells, Powys)
Jon Wilks – Town Crier (Cowbridge, Vale of Glamorgan)



Stephen Clarke, Town Crier of NSW Central Coast, Australia, plays a fanfare on a Bugle before undertaking a Proclamation. This is most significant because at the top of the Gosford Coat of Arms there is a Cockerel standing on the bugle. Gosford is the capital of the NSW Central Coast and Stephen has been the official Town Crier there since 1990.

Town Criers - Roll of Honour



NORTHERN IRELAND

John Cartwright – Town Crier (Ballynahinch, County Down)
Toastmaster Gary Wilson (Enniskillen)



AUSTRALIA

Bob Townshend – Town Crier (Southern Downs Regional Council, Queensland, Australia)
Stephen Clarke OAM – Town Crier (Central Coast Council, New South Wales, Australia)
Gavin Barker – Town Crier (Moorabool Shire, Australia)
Tom Benny – Honary Town Crier (City of Salisbury, South Australia)
Judith Cambell – Town Crier (Campaspe Shire, Victoria & Murray River Council, New South Wales, Australia)
Ken Ashford – Town Crier (Fraser Coast Regional Council, Australia)
Joseph McGrail-Bateup – Town Crier (Queanbeyan, Australia)
Alan Moyse – Town Crier (Bega Valley Shire, Australia)
Bill Wallace – Town Crier (Municipality of Lane Cove, New South Wales, Australia)
James Carter – Town Crier (Strathbogie Shire, Victoria, Australia)
Frederick Krebs – Town Crier (City of Redcliff, Queensland, Australia)
Timothy Keith – Town Crier (Parkes Shire, New South Wales, Australia)
Graham Keating – Town Crier (City of Sydney, New South Wales, Australia)
Mark Overell – Town Crier (City of Ipswich, Queensland, Australia)
Syd Norman – Town Crier (Scenic Rim Regional Council, Australia)
Philip Greenbank, President, Australasian Guide of Town Criers & – Town Crier (Hepburn Shire, Victoria, Australia)
Mike Willett – Town Crier (Victor Harbour, Australia)
Kyle Frederick Sturgess – Town Crier (Bland Shire, New South Wales, Australia)
Kevin Howarth – Town Crier (Toowoomba Regional Council, Queensland, Australia)



Patrick M Sirianni, Town Crier, City of Niagara Falls, Ontario, Canada. Patrick will be undertaking this unique Tribute To Her Majesty The Queen from the world famous Horseshoe Falls, also know as the Canadian Falls on the Niagara River along the Canada-United States Border.



BERMUDA

A David Frith JP – Town Crier (St George's, Bermuda)
Ed Christopher – Town Crier (City of Hamilton, Bermuda)

Town Criers - Roll of Honour



CANADA

Ken Templeman – Town Crier (Collingwood, Canada)
Tom Kerr – Town Crier (Municipality of Trent Hills, Canada)
Bruce C Kruger MB SBTJ – Town Crier (Bracebridge, Ontario, Canada)
Jenn Olivero – Town Crier (Hanover, Canada) & Secretary to the Ontario Guild of Town Criers
David McKee – Town Crier (Brantford, Canada)
Gary Long – Town Crier (Canning & Berwick, Nova Scotia, Canada)
Athol Hart – Town Crier (Newmarket, Ontario, Canada)
Stephen J Travers – Town Crier (City of Barrie, Ontario, Canada)
John Webster – Town Crier (City of Markham & Towns of Aurora, East Gwillimbury & Cary, Canada)
David Vollick – Town Crier (City of Burlington, Ontario, Canada)
Tom Pekar – Town Crier (Port Colborne, Ontario, Canada)
Wes Libbey – Town Crier (Stormont, Dundas & Glengary Historical Society, Cornwall, Ontario, Canada)
Patrick M Sirianni – Town Crier (City of Niagara Falls, Ontario, Canada)
Liam Cragg – Town Crier (Township Alnwick / Haldimand, Ontario, Canada)
Daniel Richer Dit Lafleche – Town Crier (Ottawa, Canada)
Brian Mabee – Town Crier (1000 Islands known as Gananoque, Ontario, Canada)
James Stewart – Town Crier (New Glasgow, Nova Scotia, Canada)
Larry Davis – Town Crier (Brant County, Ontario, Canada)



HAWAII

Hardy Spoehr – Town Crier (Honolulu, Hawaii). Hardy will be undertaking the 'Cry' from the steps of the 'IOLANI PALACE, the home of the Kings and Queens of Hawaii



NEW ZEALAND

James Donald - Town Crier (Howick, New Zealand)
Lyal Brenton JP - Town Crier (Palmerston North, New Zealand)
Paddy-Ann Pemberton – Town Crier (Central Otago, New Zealand)
Lynley McKerrow – Town Crier (Southland Council, New Zealand)

(more acknowledgements to follow)

The Queen's Platinum Jubilee Beacons

Partner



**"abrdn is delighted to be a Partner of
The Queen's Platinum Jubilee Beacons
which are being lit on 2nd June 2022
in celebration of The Queen's Platinum Jubilee.**

**This is a momentous occasion
and we wish all those taking part around the world
a very happy and joyous celebration."**

*Sir Douglas Flint
Chairman*

The Queen's Platinum Jubilee Beacons *Partner*



**"L Holding Ltd is delighted and extremely proud,
to be a Partner of The Queen's Platinum Jubilee Beacons
being lit on 2nd June 2022, in celebration of
The Queen's Platinum Jubilee."**

Mr WeeKuang Tai MLJ RNA MNA.

The Queen's Platinum Jubilee Beacons

Supporters

THE FOUR PEAKS WALKING WITH THE WOUNDED



ENGLAND
Scafell Pike



SCOTLAND
Ben Nevis



WALES
Mount Snowdon



NORTHERN IRELAND
Slieve Donard



The Queen's Platinum Jubilee Beacons

Supporters



Local
BBC Radio

BBC RADIO
Berkshire

BBC RADIO
Bristol

BBC RADIO
Cambridgeshire

BBC RADIO
Cornwall

BBC RADIO
Cumbria

BBC RADIO
CWR

BBC RADIO
Derby

BBC RADIO
Devon

BBC
Essex

BBC RADIO
Gloucestershire

BBC RADIO
Guernsey

The Queen's Platinum Jubilee Beacons

Supporters

BBC RADIO
Hereford &
Worcester

BBC RADIO
Humberside

BBC RADIO
Jersey

BBC RADIO
Kent

BBC RADIO
Lancashire

BBC RADIO
Leeds

BBC RADIO
Leicester

BBC RADIO
Lincolnshire

BBC RADIO
London

BBC RADIO
Manchester

BBC RADIO
Merseyside

BBC RADIO
Newcastle

BBC RADIO
Norfolk

BBC RADIO
Northampton

BBC RADIO
Nottingham

BBC RADIO
Oxford

BBC RADIO
Sheffield

BBC RADIO
Shropshire

The Queen's Platinum Jubilee Beacons

Supporters



Belfast Telegraph



The Church of Scotland

The Queen's Platinum Jubilee Beacons

Supporters



Creative & Commercial



The Queen's Platinum Jubilee Beacons

Supporters



The Queen's Platinum Jubilee Beacons

Supporters



National Trust



The Queen's Platinum Jubilee Beacons

Supporters



Un Llais Cymru



One Voice Wales



The Police Treatment Centres



QUEEN'S
COMMONWEALTH
TRUST

PLATINUM JUBILEE 2022



Scottish
Land & Estates



SLCC
For Local Council Professionals

The Queen's Platinum Jubilee Beacons

Supporters



TRINITY HOUSE



Lambeth Palace, London
Supported by 21CC Group Ltd



United Nations
Educational, Scientific and
Cultural Organization



Frontiers of the
Roman Empire
inscribed on the World
Heritage List in 2005

1900

HADRIAN'S WALL
AD122 - 2022



VisitBritain®



VisitEngland™



Bruno Peek LVO OBE OPR
Pageantmaster
The Queen's Platinum Jubilee Beacons
Telephone: + 44 (0) 7737 272 913
Email: brunopeek@mac.com

The playing of DIU REGNARE
Piper Liaisons, Piper Robert Procter & Piper Stuart Letford
Susan Osborne Msc FRSA, NHS Liaison Director
Baizhou Cai, Chinese Community Liaison (UK)

Bruno Peek LVO OBE PR, Pageantmaster
will NOT be available via email from
12noon on 30th May through to 6th June 2022
but will be contactable on + 44 (0) 7737 262 913
from 7am through to 10pm GMT.

*Front and back cover photograph:
The Coronation of Queen Elizabeth II, by Cecil Beaton. © Victoria and Albert Museum, London.
Guide designed by TMS Media +44 (0)1493 662929*

